

PROCEEDINGS OF SPIE

[SPIDigitalLibrary.org/conference-proceedings-of-spie](https://spiedigitallibrary.org/conference-proceedings-of-spie)

The instrument development and selection process for the Giant Magellan Telescope

Jacoby, George, Bouchez, A., Colless, M., DePoy, D., Fabricant, D., et al.

George H. Jacoby, A. Bouchez, M. Colless, D. DePoy, D. Fabricant, P. Hinz, D. Jaffe, M. Johns, P. McCarthy, P. McGregor, S. Shectman, A. Szentgyorgyi, "The instrument development and selection process for the Giant Magellan Telescope," Proc. SPIE 8446, Ground-based and Airborne Instrumentation for Astronomy IV, 84461G (24 September 2012); doi: 10.1117/12.925402

SPIE.

Event: SPIE Astronomical Telescopes + Instrumentation, 2012, Amsterdam, Netherlands

The instrument development and selection process for the Giant Magellan Telescope

George H. Jacoby^{*a}, A. Bouchez^a, M. Colless^b, D. DePoy^c, D. Fabricant^d, P. Hinz^e, D. Jaffe^f, M. Johns^a, P. McCarthy^a, P. McGregor^g, S. Shectman^h, A. Szentgyorgyi^d

^aGiant Magellan Telescope Organization, 251 S. Lake Ave, Pasadena, CA 91101; ^bAustralian Astronomical Observatory, PO Box 296 Epping, NSW 1710, Australia; ^cDepartment of Physics and Astronomy, Texas A&M University, College Station, TX 77843; ^dHarvard-Smithsonian Center for Astrophysics, 60 Garden St., Cambridge, MA 02138; ^eSteward Observatory, University of Arizona, 933 North Cherry Ave, Tucson, AZ 85721; ^fDepartment of Astronomy, University of Texas at Austin, Austin, TX; ^gResearch School of Astronomy and Astrophysics, The Australian National University, Cotter Road, Weston, ACT, 2611, Australia; ^hCarnegie Observatories, 813 Santa Barbara St., Pasadena, CA 91101

ABSTRACT

The Giant Magellan Telescope (GMT) is a 25.4-m optical/infrared telescope constructed from seven 8.4-m primary mirror segments. The collecting area is equivalent to a 21.6-m filled aperture. The instrument development program was formalized about two years ago with the initiation of 14-month conceptual design studies for six candidate instruments. These studies were completed at the end of 2011 with a design review for each. In addition, a feasibility study was performed for a fiber-feed facility that will direct the light from targets distributed across GMT's full 20 arcmin field of view simultaneously to three spectrographs. We briefly describe the features and science goals for these instruments, and the process used to select those instruments that will be funded for fabrication first. Detailed reports for most of these instruments are presented separately at this meeting.

Keywords: GMT, ELT, spectrograph, integral-field spectrograph, multi-object spectrograph, optical instruments, infrared instruments, adaptive optics, imaging

1. INTRODUCTION

The choice and sequencing of instruments play critical roles in determining the science areas that GMT will be best able to address and what techniques can be brought to bear on the contemporary questions when the telescope begins science operations. The selection of instruments is influenced by a complex interplay of many factors (see Section 3), including science impact, technical feasibility, and cost. In order to better inform our choices, the Giant Magellan Telescope Organization GMTO funded the early design phases for six candidate facility instruments. In addition, GMTO supported a feasibility study for a general-purpose fiber-feed facility that allows multiplexed spectroscopy across the full 20 arcmin field of view of the telescope. Jaffe¹ described earlier concepts of these instruments.

In this paper, we describe the goals of the design studies, the processes that were followed starting with the notional concepts for the instruments, their conceptual designs and reviews, and most recently, the recommendations that formed the basis for the instrument roadmap. We provide short descriptions for each instrument – the science it will be able to accomplish, its technical parameters, and where it stands in the roadmap; detailed descriptions for all or part of the seven designs are presented elsewhere in this conference.

We restrict the scope of this paper to facility instrumentation. GMTO also allows scientists to build or procure smaller special-purpose instruments provided that they meet the usual kinds of “visitor” or “PI” instrument requirements.

* [gjacob@gmto.org](mailto:gjacoby@gmto.org); phone: +1 520 904-4135; www.gmto.org

Table 1 summarizes key GMT parameters that provide a background for the instrumentation discussion. An overview of the facility is presented elsewhere at this meeting². Based on the telescope's attributes, potential instruments can exploit the following strengths, at least relative to current facilities:

- The large collecting area introduces a bias for spectroscopy, especially at high spectral resolution (five of the six candidate instruments are chiefly spectrographs).
- The large diameter, in combination with AO emphasizes high spatial resolution (four of the six candidates are designed for AO corrected fields).
- GMT's wide field motivates survey spectroscopy (two of the candidates utilize fields of 6 arcmin or larger, and three can be fed by the full-field, 20 arcmin, fiber facility).
- The site location offers scientific investigations of the Magellanic Clouds and Galactic Bulge, and synergies with Magellan, ALMA, LSST, E-ELT, and CCAT, leading to survey/wide-field/MOS opportunities.

Table 1. Key GMT telescope parameters.

Parameter	Value
Aperture largest diameter	25.4-m
M1 f/ratio	~0.7
Aperture, collecting area	368-m ²
Final f/ratio, narrow- / wide-field	8.16 / 8.34
Unvignetted field of view, narrow / wide	~7 / 20* arcmin (diameter)
Number of reflections, AO / natural	3 / 2
Plate scale, narrow- / wide-field	0.994 / 0.972 arcsec/mm
Median seeing (V-band), FWHM	0.63 arcsec
Adaptive optics correction	Adaptive M2
Strehl, JHK (median conditions), NGS AO	0.39 / 0.60 / 0.75
Strehl, JHK (median conditions), LTAO	0.13 / 0.30 / 0.53
GLAO RIJHK (median conditions), FWHM	0.45 / 0.41 / 0.33 / 0.26 / 0.19 arcsec
Natural RIJHK (median conditions), FWHM	0.54 / 0.51 / 0.45 / 0.40 / 0.36 arcsec
Telescope location	Las Campanas

*Wide-field operation suffers slight vignetting from the active optics wavefront sensors

1.1 Adaptive optics (AO)

GMT delivers AO-corrected images³ to the instruments installed at the folded ports provided that the instrument complies with the wavefront sensor requirements. These include:

1. A dichroic window to the instrument, tilted to direct visible light (shortward of 960 nm) toward the sensors in items 2 and 3.
2. A natural guide star wavefront sensor for NGS AO (external)
3. A laser guide star wavefront sensor for LTAO (external)
4. An infrared tip-tilt and truth wavefront sensor for LTAO (internal)

In addition, GMT supports a GLAO mode that provides partial atmospheric correction over fields up to 7 arcmin in diameter. The GMT project is currently evaluating the trade-offs between using a wide laser constellation (LGLAO) or using natural guide stars monitored by the deployable active optics wavefront sensors (NGLAO). The latter approach has

several advantages; in particular, it can be used nearly 100% of the time and eliminates the need for a large dichroic to split off the laser guide star light, thereby allowing use by instruments at all mount locations.

1.2 Instrument mounting locations

GMT provides 3 primary locations to mount instruments². Figures 1 and 2 show the Gregorian Instrument Rotator (GIR) Folded Port (FP) level, which is designed to support small- to moderate-sized instruments, up to 6,500 kg including all associated equipment and AO sensors, and within a volume of 3.5 x 5.5 x 1.9-m. The name derives from the fact that the telescope beam is folded by the facility tertiary, located 1-m above a rotating platform and 1.1-m below the bottom of the primary mirror cells. Three instrument quadrants are available on the rotating FP platform; the fourth quadrant is reserved for utility functions, such as the tertiary deployment stage, the GLAO wavefront sensors, and perhaps an instrument-specific tertiary. The facility tertiary will have an IR-efficient coating, while M1 and M2 will initially be coated with aluminum. Instruments are selected by inserting/rotating the tertiary; the tertiary is removed to feed the instruments housed below.

The GIR ports are located below the FP and are directly fed by M2 in the narrow-field mode, or from M2 through a wide-field corrector and atmospheric dispersion compensator (ADC) for the full 20 arcmin field. Four GIR locations (Figure 3) are available for instruments having sizes up to 2.8 x 2.8 x 5.5-m and having weights up to 11,500 kg fully inclusive (with electronics, racks, cables). Instruments shuttle radially onto the central optical axis as needed. If they are small enough, an instrument may occupy a partial GIR bay, providing space for an additional instrument below it; in that case, the lower instrument must include an elevation stage to raise it to the position of the focal plane.

The Gravity Invariant Station (GIS) is located on the telescope azimuth disk. Space is allocated for a single large instrument weighing up to 20,000 kg. The telescope feed to a GIS instrument is the responsibility of the instrument, either by fibers or via an optical relay.

GMT provides three additional instrument locations. These are not well-defined yet because there are no candidate instruments to drive the development of these ports. Two ports are located beyond the elevation bearing journals (one on either side). Instruments at these locations can provide a counter-rotation to the telescope elevation in order to effect a gravity invariant condition. There is also a mounting location for an instrument on the fixed portion of the Instrument Platform, outside the FP.

1.3 Utilities

All instruments will be provided with the required utilities: AC mains and UPS power, Ethernet ports, cryo-cooler lines, dry nitrogen/air, and a chilled liquid to remove excess heat. Instrument lifts are available for installing the FP or the GIR instruments. The GIR lift represents a special case – it rises through the center of the pier and up through the center of the GIR. The instrument is mounted onto the lift using the fixture that will install into the GIR and is then translated on rails into its GIR stow position. A nearby auxiliary building provides space and utilities for instrument assembly, testing, repairs, and upgrades.

2. INSTRUMENT PROGRAM DEVELOPMENT HISTORY

The same science drivers that motivated the GMT telescope project also provided the scientific motivation for the instrument development and selection process. These were prepared initially in 2006⁴ and have been revised to reflect scientific changes in the field and the interests of new GMT member institutions. The basic mapping between science and instruments is shown in Figure 4.

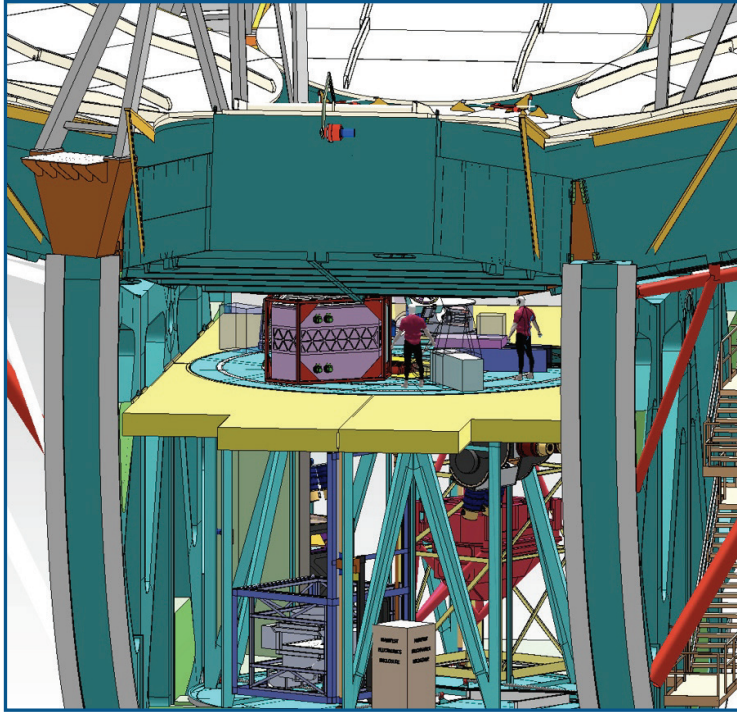

Figure 1. Side view showing primary mirrors and cells with the rotating Folded Port (FP) location just below. The Gregorian Instrument Rotator (GIR) instruments install under the FP.

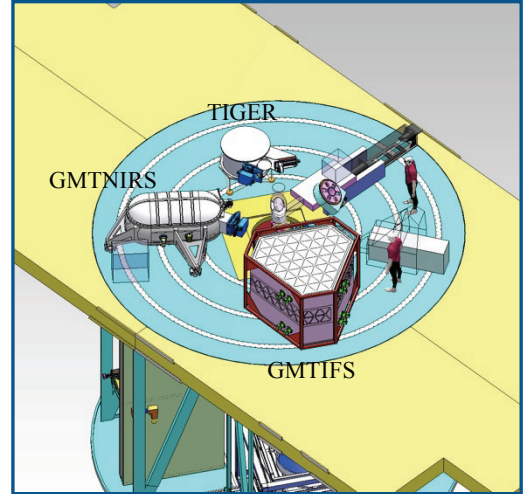

Figure 2. Top view of the FP instruments on the rotating disk. Beyond the central disk is a non-rotating platform that is used to install or remove instruments on one side, and to provide a stationary mount point for another instrument on the other side.



Figure 3. The GIR showing three stowed instruments (left): NIRMOS, MANIFEST, and one of the two GMACS optics modules with its optics feed (includes field lens, tent mirrors, and slit mask exchanger). The right-hand image shows NIRMOS on axis for observing.

Science Topic	Instrument						MANIFEST			Modes
	GMACS	NIRMOS	G-CLEF	GMTNIRS	TIGER	GMTIFS	G	N	C	
Formation of Stars and Planetary Systems										
2.1 From Stars to Planets	Very important	Very important	Very important	Very important	Very important	Very important	Very important	Very important	Very important	PRV, transit spectroscopy
2.2 Young Stars	Very important	Very important	Very important	Very important	Very important	Very important	Very important	Very important	Very important	Spectroscopy
2.3 The IMF and Planets	Very important	Very important	Very important	Very important	Very important	Very important	Very important	Very important	Very important	Imaging modes
2.4 Disk Evolution	Very important	Very important	Very important	Very important	Very important	Very important	Very important	Very important	Very important	"
2.5 System Architecture	Very important	Very important	Very important	Very important	Very important	Very important	Very important	Very important	Very important	PRV, High-resolution spectra
2.6 Solar System Studies	Very important	Very important	Very important	Very important	Very important	Very important	Very important	Very important	Very important	Imaging modes/channels
Properties of Exoplanetary Systems										
3.1 Formation models	Very important	Very important	Very important	Very important	Very important	Very important	Very important	Very important	Very important	High-resolution spectroscopy
3.2 Atmospheres	Very important	Very important	Very important	Very important	Very important	Very important	Very important	Very important	Very important	coronagraphy, high-contrast
3.3 Imaging Exoplanets	Very important	Very important	Very important	Very important	Very important	Very important	Very important	Very important	Very important	PRV, high-contrast imaging
3.4 Habitable Worlds	Very important	Very important	Very important	Very important	Very important	Very important	Very important	Very important	Very important	"
Stellar Populations and Chemical Evolution										
4.1 Populations Studies	Very important	Very important	Very important	Very important	Very important	Very important	Very important	Very important	Very important	AO imaging, high-res. Spec.
4.2 Stellar Archeology	Very important	Very important	Very important	Very important	Very important	Very important	Very important	Very important	Very important	High-resolution spectroscopy
4.3 Abundances in Dwarfs	Very important	Very important	Very important	Very important	Very important	Very important	Very important	Very important	Very important	"
4.4 Milky Way Halo	Very important	Very important	Very important	Very important	Very important	Very important	Very important	Very important	Very important	"
4.5 Globular Clusters	Very important	Very important	Very important	Very important	Very important	Very important	Very important	Very important	Very important	AO Imaging, moderate res. Spec.
Assembly of Galaxies										
5.2 Local Dwarf Galaxies	Very important	Very important	Very important	Very important	Very important	Very important	Very important	Very important	Very important	Multiobject high res. spectroscopy
5.3.1 Mass Assembly	Very important	Very important	Very important	Very important	Very important	Very important	Very important	Very important	Very important	Multiobject mod. Res. spectroscopy
5.3.2 Dynamical Masses	Very important	Very important	Very important	Very important	Very important	Very important	Very important	Very important	Very important	IFU spectroscopy
5.3.3 Gas Kinematics	Very important	Very important	Very important	Very important	Very important	Very important	Very important	Very important	Very important	IFU spectroscopy, MOS spectroscopy
5.3.4 Mass-Metallicity Relation	Very important	Very important	Very important	Very important	Very important	Very important	Very important	Very important	Very important	visible & NIR spectroscopy
5.3.5 Feed-back and the IGM	Very important	Very important	Very important	Very important	Very important	Very important	Very important	Very important	Very important	IFU spectroscopy, MOS spectroscopy
5.4 Black Hole Masses	Very important	Very important	Very important	Very important	Very important	Very important	Very important	Very important	Very important	IFU Spectroscopy, AGN spectra
Dark Matter, Dark Energy & Fundamental Physics										
6.1 Cosmological Parameters	Very important	Very important	Very important	Very important	Very important	Very important	Very important	Very important	Very important	Survey followup
6.2 LSST Follow-up	Very important	Very important	Very important	Very important	Very important	Very important	Very important	Very important	Very important	"
6.3 Clusters & Dark Matter	Very important	Very important	Very important	Very important	Very important	Very important	Very important	Very important	Very important	Spectroscopy, IFU
6.4 Dark Matter in Dwarfs	Very important	Very important	Very important	Very important	Very important	Very important	Very important	Very important	Very important	Multiobject high res. Spectroscopy
First Light & Reionization										
7.2 First Stars & Galaxies	Very important	Very important	Very important	Very important	Very important	Very important	Very important	Very important	Very important	near-IR spectroscopy
7.3 Early Galaxies	Very important	Very important	Very important	Very important	Very important	Very important	Very important	Very important	Very important	visible & NIR spectroscopy
7.4 Population III Stars	Very important	Very important	Very important	Very important	Very important	Very important	Very important	Very important	Very important	"
7.5 Probing Reionization	Very important	Very important	Very important	Very important	Very important	Very important	Very important	Very important	Very important	High & mod. Res. Spectroscopy
7.6 HI Topology	Very important	Very important	Very important	Very important	Very important	Very important	Very important	Very important	Very important	Ly alpha imaging, spectra
7.7 IGM Spectroscopy	Very important	Very important	Very important	Very important	Very important	Very important	Very important	Very important	Very important	High resolution spectroscopy
Transient Phenomena										
8.2 Long-Duration GRBs	Very important	Very important	Very important	Very important	Very important	Very important	Very important	Very important	Very important	High res. Spectroscopy, photometry
8.3 Supernovae	Very important	Very important	Very important	Very important	Very important	Very important	Very important	Very important	Very important	Low res. Spectroscopy, polarimetry
8.4 Other Transients	Very important	Very important	Very important	Very important	Very important	Very important	Very important	Very important	Very important	spectroscopy, photometry

Figure 4. The GMT science goals are mapped against the scientific capabilities of the six candidate instruments. The role of MANIFEST is shown for its host instruments: GMACS, NIRMOS, and G-CLEF.

2.1 Activity before conceptual design

During the run-up to the telescope conceptual design review in 2006, several notional instruments⁵ were under consideration including the instruments currently known as GMACS, GMTNIRS, NIRMOS, and TIGER. GMTIFS, G-CLEF, and MANIFEST originated in response to a call for proposals that was issued in early 2009. Twelve letters of intent were received in response to that call and nine proposals were submitted. Six of the nine instruments were granted funding in 2010 to advance the instrument designs to the conceptual design level. In addition, MANIFEST was funded

to demonstrate the technical feasibility of the proposed fiber positioner scheme, and to ensure that its three host instruments would be designed to accommodate its feed. The main features of the seven studies under contract are summarized in Table 2.

Table 2. Summary of basic instrument parameters

Instrument	Function	λ Range, μm	Resolution	Field of View
G-CLEF*	Optical High Resolution Spectrometer	0.35 – 0.95	20 – 100K	7 x 1" fibers
GMACS*	Optical Multi-Object Spectrometer	0.36 – 1.0	1500 – 4000, 10,000	40 – 80 arcmin ²
GMTIFS	NIR AO-fed IFU / Imager	0.9 – 2.5	4000 – 10,000	10 / 400 arcsec ²
GMTNIRS	Near-IR AO-fed High Resolution Spectrometer	1.2 – 5.0	50 – 100K	Single Object
NIRMOS*	Near-IR Multi-Object Spectrometer	0.9 – 2.5	2700 – 5000	42 arcmin ²
TIGER	Mid-IR AO-fed Imager and Spectrometer	1.5 – 14	300	0.25 arcmin ²
MANIFEST	Facility Robotic Fiber Feed	0.36 – 1.0		300 arcmin ²

*GMACS, NIRMOS, and G-CLEF can be fed by the facility fiber feed, MANIFEST. In this mode, these instruments have extended capabilities, including access to the full 20 arcmin diameter field of view, additional MOS inputs, multi-IFU inputs, and enhanced spectral resolution when fed with image slicers.

2.2 Conceptual design studies

Each of the instrument teams were contracted to develop a conceptual design over a period of about 14 months. The study period was monitored with monthly status updates and quarterly reviews. The contracts culminated in September/October 2011 with a two-day, design review (CoDR) evaluated by 5-7 expert panelists selected from outside the GMT project and recruited specifically for each instrument to ensure a match to the technology and science. Other deliverables included all the engineering files (CAD, Zemax), all the materials presented to the review panel, a detailed cost and contingency estimate, a risk assessment, and a fully operational exposure time calculator. In addition, the teams were asked to identify de-scope (or deferral) options and the associated cost savings. The concept design studies also served as a means for the Project Office to work with the instrument teams in designing interfaces and estimating the facility requirements (power, cooling, weights, sizes).

Each panel was given 2 weeks to submit a written report on the instrument design materials. The panel was charged with addressing the following aspects of the design:

1. The instrument's scientific potential
2. The feasibility of the technical approach, the risks and their mitigation schemes, the match between the instrument and its requirements
3. The team's management structure
4. The credibility of the fabrication estimate

The instrument teams were offered the opportunity to prepare a response to the panel's report, and all did so. In some cases, the team submitted an amended design report with significant additional information. All material from the conceptual design phase, including the panel reports and team responses, were provided to the Instrumentation Development Advisory Panel (IDAP; see Section 3) as background information in preparing the GMT instrumentation roadmap.

2.3 MANIFEST feasibility study

The facility fiber feed (MANIFEST) was viewed early on as having very significant potential to leverage the scientific impact of GMT by greatly extending the capabilities of several instruments and providing wide-field coverage. In principle, one can observe with the three host instruments simultaneously. However, MANIFEST is not an instrument in itself and its downstream value could be lost if the instrument selection process went in an orthogonal direction. Consequently, the team was asked to continue development of the technology, but not to the level of a conceptual

design. A feasibility study was funded first for 12 months, and then extended for an additional 9 months, in order to demonstrate that the proposed technology was viable.

The deliverables for the MANIFEST study were identical to those for the conceptual design studies, but there was no requirement for an exposure time calculator and the final review has not yet been held. In some cases, the relevant instrument team included a mode for MANIFEST in their calculators. The MANIFEST study reports were also provided to the IDAP for consideration in developing the instrument roadmap.

2.4 Instrument overview

Each of the instrument teams is represented at this meeting. Consequently, to avoid redundancy while striving for completeness, this paper presents a very brief summary of each instrument. The references contain far more details.

2.4.1 G-CLEF⁶

The GMT-CFA, Carnegie, Catolica, Chicago Large Earth Finder (G-CLEF) is a fiber-fed optical echelle spectrograph. It serves as both a general high resolution spectrograph and also as a precision radial velocity spectrograph. G-CLEF primarily targets the following science areas:

- A census and characterization of the most metal poor halo and Local Group dwarf galaxy stars
- The discovery and characterization of exoearths and exosolar systems, especially habitable planets
- Abundances in and evolution of galaxies in the Local Group and beyond
- Probing the IGM and ISM at high z

G-CLEF is based on an asymmetric white pupil, dual-beam design. It uses a precision vacuum enclosed thermal control system to provide good throughput, excellent stability, and resolutions of 25,000, 40,000, or 120,000 depending on the choice of fiber input (large 1.2" fiber for high throughput, 0.7" for precision abundances, or a pupil sliced 0.7" fiber set for velocities). G-CLEF can also be fed by MANIFEST to provide MOS or IFU capability. The optical design is shown in Figure 5. G-CLEF is mounted at GMT's gravity invariant station on the azimuth disk (Figure 6).

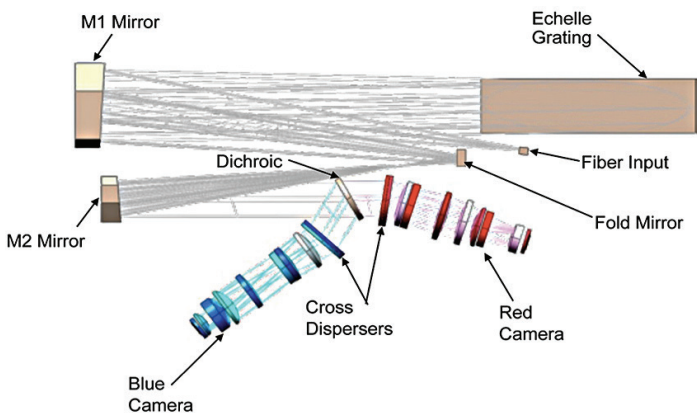

Figure 5. G-CLEF optical layout

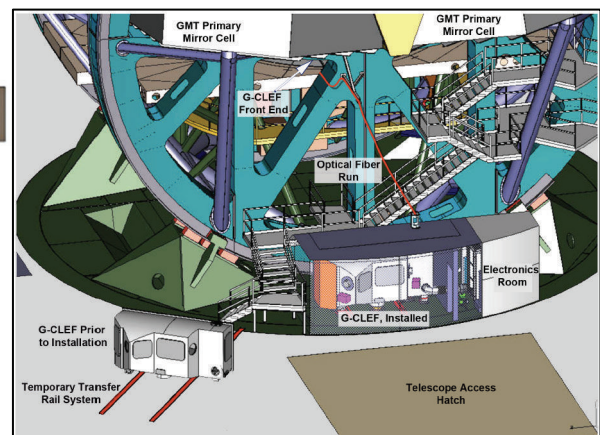

Figure 6. G-CLEF's mount location on the azimuth disk. The access hatch in the dome floor is shown, along with the temporary rail system used for installation.

2.4.2 GMACS⁷

The GMT Areal Camera and Spectrograph (GMACS) is a general purpose, medium resolution, optical, multi-object spectrograph. GMACS uses a set of four fold mirrors at the GMT focal plane to redirect a 9 x 18 arcmin field of view to four individual "arms", each consisting of a two-channel spectrograph. Each spectrograph shares a collimator. The wide

field is provided by the facility wide-field corrector and ADC, allowing GMACS' wavelength coverage to extend from ~370 to ~950 nm. GMACS can also be fed by MANIFEST for access to the full 20 arcmin field of view and to provide a higher object density than its native slit mask mode, or to add a multi-IFU mode, or to use an image sliced mode for higher resolution ($R \sim 10,000$). Nominally, the resolution will be between 1000 to 5,000, depending on the wavelength and whether the high or low resolution grating is used. Resolution will also depend on seeing conditions, as the spectral resolution element is well oversampled. GMACS also can be used in the NGLAO mode to improve resolution and depth in the far red.

The opto-mechanical design^{8,9} (Figure 7 and 8) allows "arms" of GMACS to be deployed in stages of 1, 2, or 4 arms within the GIR (Figure 3). The instrument roadmap for GMT recommends a modest start of one arm, but optics and detectors can be added later to complete additional arms.

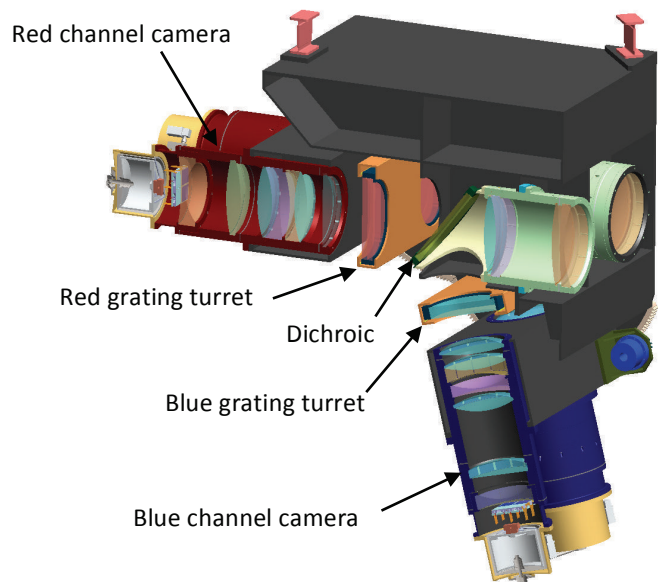

Figure 7. A cutaway view of two arms of GMACS. Mount points at the top fix the instrument within the GIR. Unlike other instruments in the GIR, the optics modules of GMACS are fixed in place.

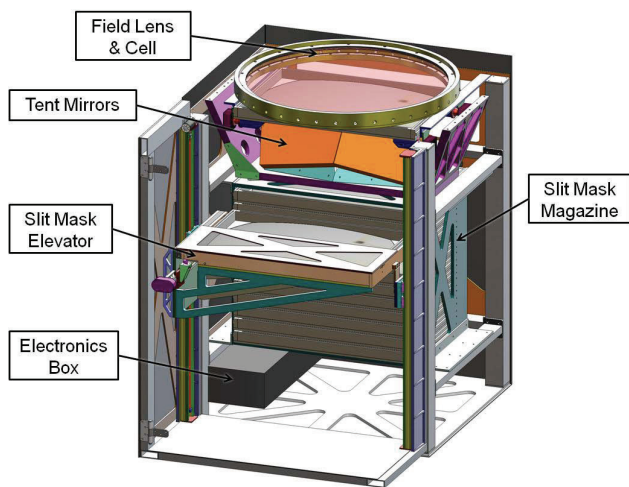

Figure 8. The focal plane assembly for GMACS, which consists of the final field lens of the wide-field corrector, the fold (tent) mirrors, and a slit mask exchanger. This assembly is mounted in the GIR and translates horizontally onto the optical axis and then vertically to the proper focal distance.

Scientifically, the wide field of GMACS, either with slit masks or the MANIFEST fiber feed, will allow for excellent efficiency as a survey spectrograph, for example, to study Ly α galaxy distributions and luminosity functions at $z > 6$, Local Group dark matter distributions, galactic halo kinematics, and Kuiper belt object surface compositions. Perhaps more importantly, GMACS will serve the same unpredictably useful workhorse function for GMT that so many "RC spectrographs" have served in the past on existing telescopes. GMACS will have a clear role to play in following up the numerous targets of interest identified by LSST, located on nearby Cerro Pachón.

2.4.3 GMTIFS¹⁰

The GMT Integral Field Spectrograph (GMTIFS) is an AO-fed near-IR (0.9-2.5 μm) imager (20.4 x 20.4 arcsec field) and IFU spectrograph. The IFU offers 4 square spaxel scales (50, 25, 12, and 6 mas) to provide fields of view of 4.40x2.25, 2.20x1.13, 1.06x0.54, and 0.53x0.27 arcsec, with spectral resolutions of 5,000 and 10,000. GMTIFS has a strong heritage in the Gemini GSAOI¹¹ and NIFS¹² instruments built by the same instrument team. The following key science areas are targeted:

- Gamma-ray bursts to probe the structure of the intergalactic medium at the epoch of reionization beyond $z \sim 7$
- Mass assembly of galaxies over cosmic time using kinematic measurements of Ly α and H α emission

- Probe massive nuclear black holes via high-angular-resolution measurements of stellar kinematics in some objects and Keplerian motions of circum-nuclear gas in other objects
- Probe the least massive nuclear black holes in nearby galaxies and investigate the duality of low-mass black holes and nuclear star clusters
- Resolve individual stars in galaxies beyond the Local Group, providing direct insights into the star formation and chemical histories of complex stellar systems
- Probe the jet outflows and planet-forming circumstellar disks associated with nearby star forming regions
- Spectroscopic studies of outer exosolar planets

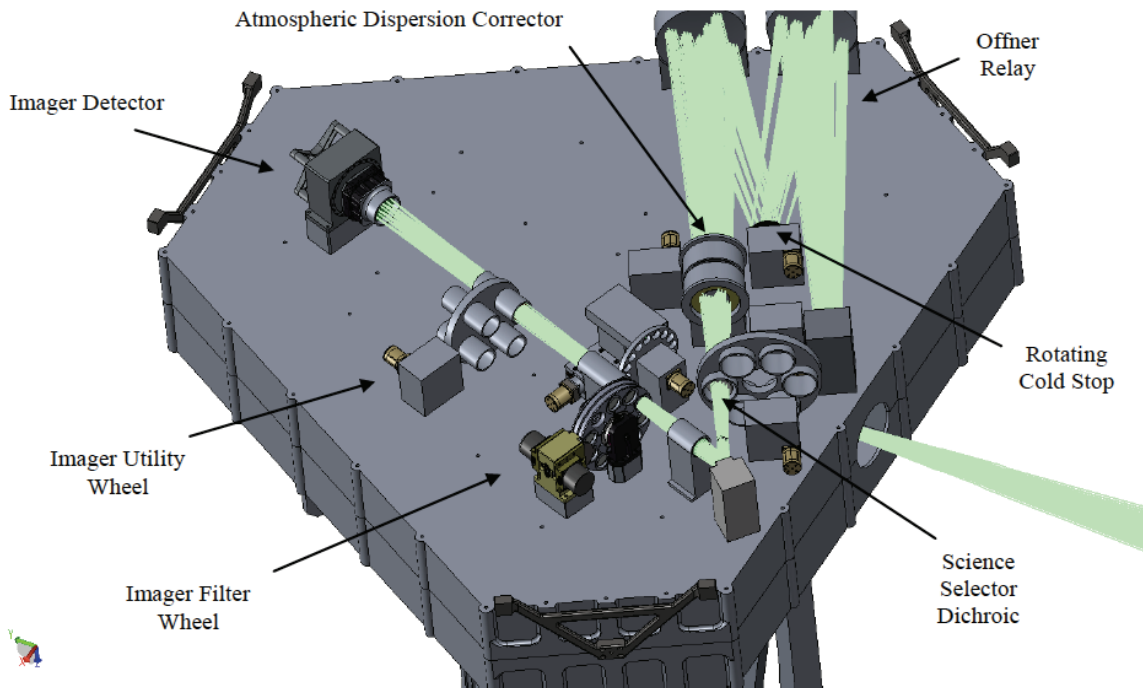

Figure 9. The GMTIFS fore-optics and imager.

GMTIFS, like other AO instruments at GMT, is an FP instrument (Figure 2). Its optics design is distributed in three levels. One level is shown in Figure 9; details are given elsewhere¹⁰. AO wavefront sensors are mounted externally at the front of the dewar (see Figure 10), and an on-instrument wavefront sensor is internal to the instrument to serve as an IR tip-tilt sensor and truth sensor.

2.4.4 GMTNIRS¹³

The GMT Near Infra-Red Spectrograph (GMTNIRS) offers full coverage spectroscopy in all five JHKLM bands, with resolutions of 50,000 at JHK and 100,000 at LM. The five spectrographs employ silicon immersion gratings to minimize the volume of the five spectrographs. GMTNIRS has considerable technical commonality with IGRINS¹⁴, an HK spectrograph with R=40,000, being built by the same instrument team. GMTNIRS has only one configuration and only one moving part (the rotating pupil mask), and so it should be easy to use, especially in a queue observing mode, and should be highly reliable.

Like GMTIFS, it is an AO-fed instrument mounted on the FP. GMTNIRS has a relatively large 85 mas entrance slit, thereby reducing the demands on the AO system and the internal wavefront sensor, while providing high throughput. Requirements on the tip-tilt star are modest, allowing all-sky coverage in LTAO mode. Targeted science areas include:

- The formation of planetary systems and their host proto-stars
- Details of the disks surrounding young stars
- Characterization of Jupiter-mass planets
- Properties of brown dwarfs

The optical layout of GMTNIRS is shown in Figure 10. The cryostat and external wavefront sensors are shown in Figure 11.

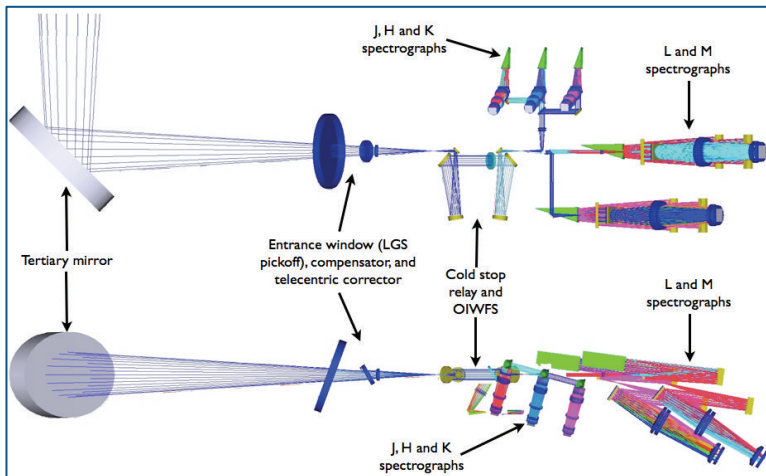

Figure 10. GMTNIRS optics, showing all 5 spectrographs and their dichroic splitters.

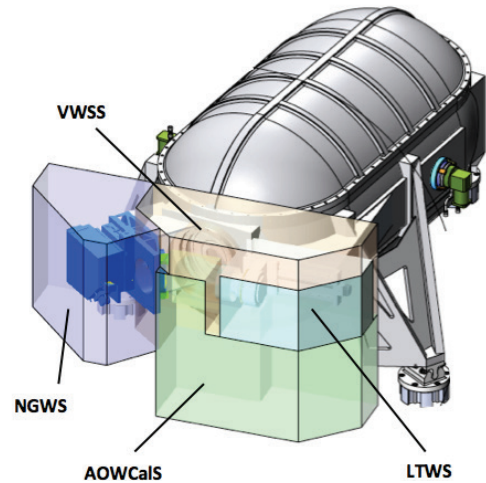

Figure 11. The GMTNIRS cryostat, which also shows the placement of the external wavefront sensors common to all the GMT AO instruments. These include the natural guide star sensor (NGWS) and the laser tomography sensor (LTWS). Also shown is the calibration source box.

2.4.5 NIRMOS¹⁵

The Near InfraRed Multiple Object Spectrograph (NIRMOS) is a 1-2.5 μm imager and multi-slit spectrograph. Like GMACS, it has a relatively wide field (6.5 x 6.5 arcmin) and medium resolution (3,000-5,000) to enable survey spectroscopy in the JHK bands. In addition, it can be fed by MANIFEST to provide a full 20 arcmin field of view. Although it is designed as a natural seeing instrument, it is tuned to work well with GLAO where the delivered images often will have FWHM <0.2 arcsec. Consequently, NIRMOS has broad scientific application with particular advantages in the following areas:

- Star formation and metal production at the peak epoch near $z \sim 2.5$
- Tracing the birth and early evolution of the first galaxies at $z > 7$
- Time-series differential spectroscopy of bright stars to measure the transmission and emission spectra of transiting exoplanet atmospheres
- The characterization of outer solar system bodies

The optical design (Figure 12) uses a selection of seven VPH gratings and an articulated camera for the spectrograph and a straight-through configuration when in imaging mode (up to 14 filters). This is an efficient design, providing a throughput (including the telescope) of 40-50% in J and H, and 30% at K; the imaging mode is 5-10% higher.

NIRMOS uses a cryogenic mask exchanger that accommodates 10 slit masks. The mask ensemble can be changed during the day; sufficient cooling capacity is provided to cool the exchanger back to operating temperature quickly.

NIRMOS is mounted in the GIR and is moved as a unit onto the optical axis or into the stowed position (Figure 3).

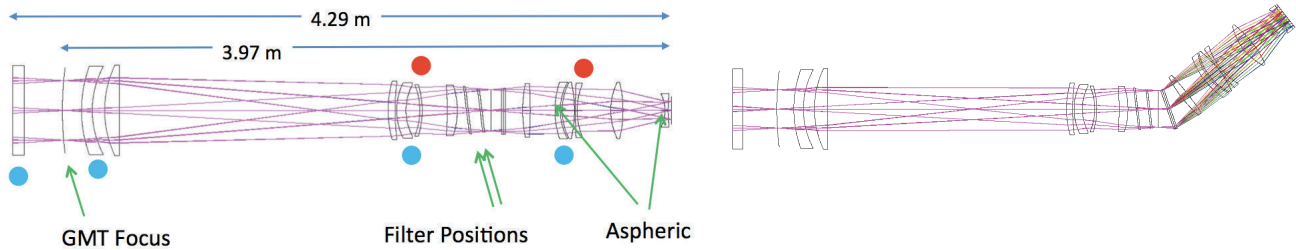

Figure 12. The optical layout for NIRMOS in the imaging mode (left) and in the spectrograph mode (right). Lenses are CaF_2 except for the red (upper) dots that are S-TIM28 and the blue (lower) dots that are Infrasil.

2.4.6 TIGER¹⁶

The Thermal Infrared imager for the GMT, providing Extreme contrast and Resolution (TIGER) is a high resolution, high contrast (10^{-6} at $2 \lambda/D$) imager and low resolution ($R \sim 300$) spectrograph. TIGER's wavelength range of 1.5-14 μm is distributed into short (1.5-5 μm) and long (7-14 μm) channels. Both channels offer a 30 arcsec field of view with pixel scales of 7 and 30 mas for the two channels, respectively. TIGER derives from earlier instruments on the MMT¹⁷ and the LBT and has similar science goals.

- Exoplanet discovery and characterization, surveys of gas giants, detection of rocky planets
- Disk and planet formation, zodiacal light studies
- Composition of Kuiper belt objects
- Characterizing the low mass end of young embedded star clusters
- Galactic center astrometry close to the central black hole
- Extragalactic star formation

Like the other AO-fed instruments, TIGER is mounted on the FP and has the same front-end external wavefront sensors as GMTIFS and GMTNIRS. Because TIGER is quite small, these sensors approach the size of the instrument. The optical layouts for the short and long wavelength channels are shown in Figure 13.

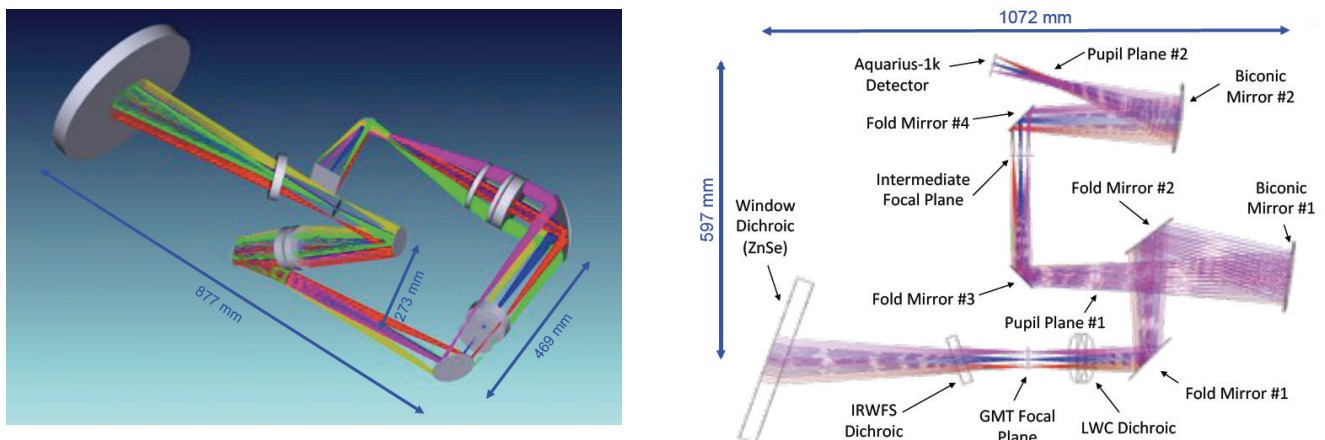

Figure 13. Optical layouts for the short (left) and long (right) channels of TIGER. The short wavelength channel is folded out of the horizontal plane to place its optics underneath the input beam and keep the overall size of the cryostat of modest size. This view is easier to visualize than the flat view used for the long wavelength channel.

2.4.7 MANIFEST¹⁸

The Many Instrument Fiber System (MANIFEST) derives from the strong background at the AAO in fiber technologies. It is based on a new kind of positioner called the starbug that is an independent robotic element carrying a fiber or fiber group (e.g. image slicer, IFU); its independence allows for rapid parallel configurations. Starbugs can be placed at a center-to-center spacing of ~ 10 arcsec, and to a positioning accuracy of $\sim 10 \mu\text{m}$ (0.01 arcsec).

With its $\sim 2,000$ starbugs, MANIFEST can feed multiple instruments simultaneously with fiber arrangements tuned for the science of the specific instrument (e.g., optical or IR). MANIFEST resides in the GIR (Figure 3) beneath one of the GMACS optics modules, and so, it must translate onto the optical axis and rise to the focal plane. It then takes advantage of the full 20 arcmin field of view of GMT provided by the wide-field corrector and ADC. The wide field dramatically improves the survey capability of GMT, providing an “A- Ω ” advantage over other facilities of at least two times, while providing a multiplexing speed gain of 2-4 times (up to ~ 40 for G-CLEF).

Scientifically, MANIFEST offers a good match for studies of the epoch of peak star formation, galaxy assembly, galaxy clustering, IGM tomography, dark matter distribution, reionization, and Local Group chemistry. When the deployed fibers are image slicers, it can dramatically improve the spectral resolution for GMACS and NIRMOS, extending their science utility.

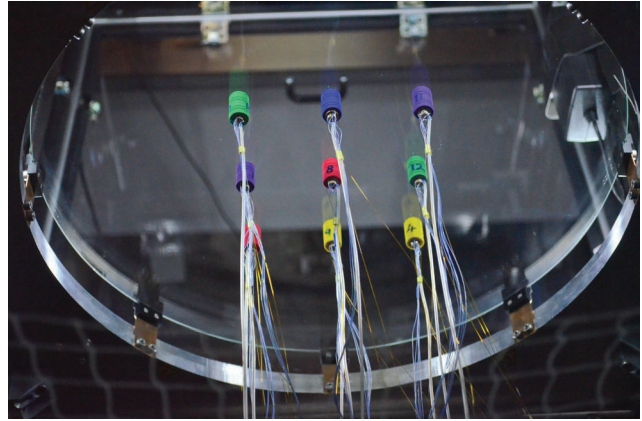

Figure 14. A view of the MANIFEST demonstrator showing 9 starbugs from below. Their control lines and fibers hang below the bug itself, which is secured to a glass plate by vacuum. The plate conforms to the shape of the GMT focal plane.

Figure 14 shows a test fixture with nine starbugs. Ultimately, there can be thousands of these, each with a limited patrol area for fast deployment times, spread over a 1.3-m glass focal plate.

3. DEVELOPING THE INSTRUMENT ROADMAP

3.1 Process

At the outset of the conceptual design studies, the GMTO Project Office and the instrument teams understood that we cannot build all the instruments that we desire at once. The construction budget is sufficient for 3-4 instruments and development must match the pace of incoming resources. GMTO needed to develop a plan, or “roadmap”, for early optimization of science impact while providing a long-term vision for fulfilling all the partner aspirations. The roadmap must also allow sufficient flexibility to take advantage of the changing technical and scientific landscape. The expertise needed to craft such a plan is widely distributed among the GMT partner community. Consequently, the GMTO Board solicited high-level advice from a select group of partner representatives to help them and the Project Office begin the process of charting that roadmap.

The GMTO Board and Science Advisory Committee formed a list of potential panelists to serve on the Instrumentation Development Advisory Panel (IDAP). The 12-member panel was comprised largely from within the GMT partnership, but included two community representatives to provide additional breadth and objectivity. The other 10 panelists were selected to provide expertise in the key areas of interest to the partner scientists (Figure 5).

The IDAP held several telecons over a two-month period in preparation for a two-day in-person meeting in February 2012. Their recommendations were sent to the GMTO Project Office and the Board about one month later.

3.2 Factors to consider

The IDAP was charged with developing a balanced instrument program. Their key high-level considerations were:

- The scientific potential of each instrument, or particular suites of instruments, guided by the science cases developed by each instrument team and the overall GMT science case
- The technical merits, risks, and readiness to advance to the preliminary design phase for each concept, and the instrument team's level of expertise
- The overall cost envelope imposed by the GMT instrumentation budget
- Operational balance with respect to bright and dark time, conditions at the site, and constraints on operation and development timeline of the adaptive optics system
- Scientific and technical areas in which the GMT can have unique impact or significant advantages compared with other relevant facilities
- Scientific synergies with facilities expected to be in operation in the same time period as GMT
- Intellectual involvement across the partnership

3.3 The implementation plan

After discussion with the GMTO Board, the Project Office developed a comprehensive, but preliminary, plan for implementing the IDAP recommendations. The plan accounts for instrument sequencing, spend profiles, contingency levels, the risk of cost overruns, and the review mechanisms needed to oversee the instrumentation program. In addition, the IDAP recommended that strategies be developed for starting second generation instruments, and that NIRMOS and TIGER be included in the pool of potential second generation instruments. Figure 15 shows the tentative roadmap. Details are still being iterated, and so the dates and durations are likely to change over the next 6-8 months. The sequence of instrument development is unlikely to change, but the timing and demarcation between first- and second-generation instruments may evolve as costs and budgets are refined.

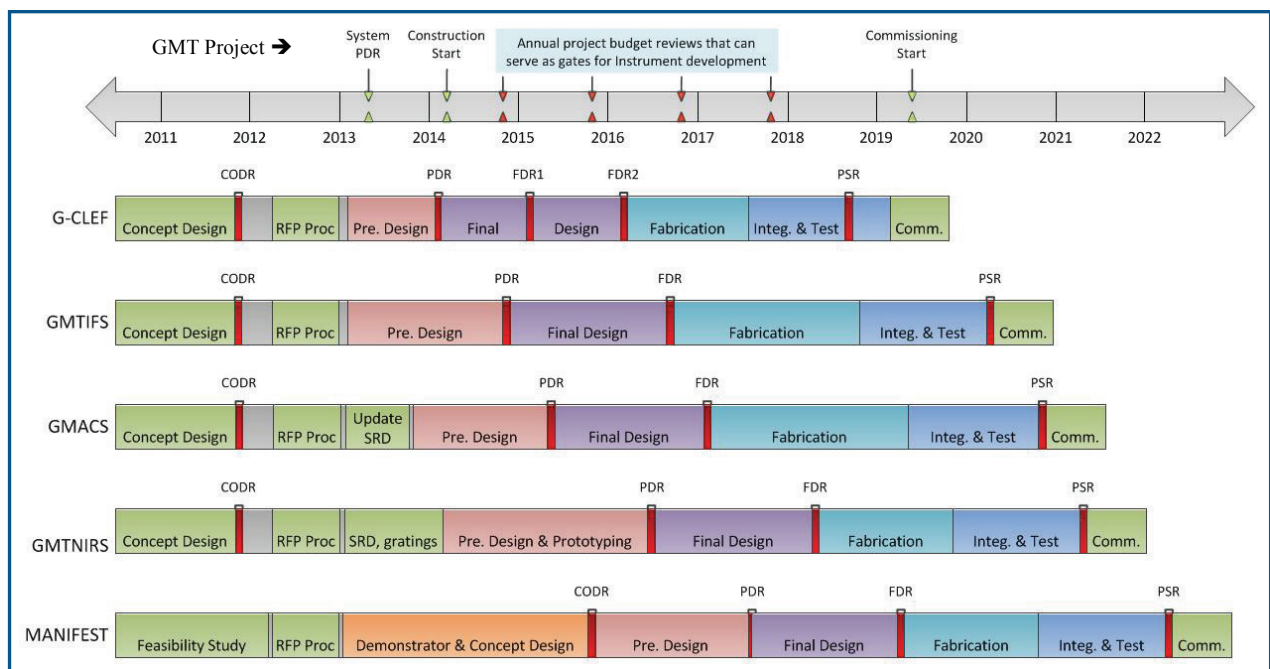

Figure 15. The current iteration of the instrumentation roadmap. The labels at the top refer to the overall GMT project (PDR, Construction, Commissioning). Four key reviews are planned for each instrument: CoDR (completed), PDR, FDR (final design review), PSR (pre-ship). Not shown are the final instrument definition and requirements review at the beginning of preliminary design and the acceptance review after commissioning.

3.4 Next steps

The Project Office is drafting RFPs for preliminary designs for the instruments shown in Figure 15. In the case of MANIFEST, this is a demonstrator and conceptual design phase. The RFPs include an initial stage for the development and review of the final instrument requirements.

After the preliminary design and a successful PDR, the Project Office and Board will be better able to decide if all four instruments can proceed to final design and fabrication, and how MANIFEST is best developed and integrated into the facility. Costs, risks, and contingency requirements will be re-evaluated in the 2015-2016 period.

4. SECOND-GENERATION INSTRUMENTS

Figure 16 illustrates one concept for bringing second generation instruments into the mix. Again, this figure is very preliminary. The cost estimates are notional, but consistent with the range of costs for most first generation estimates. The process tentatively begins shortly before the facility construction starts and leads to a delivered instrument in 2025. Funding for second generation instruments (and beyond) is provided from the operations budget. Consequently, this roadmap is designed to flow seamlessly into the operations funding stream.

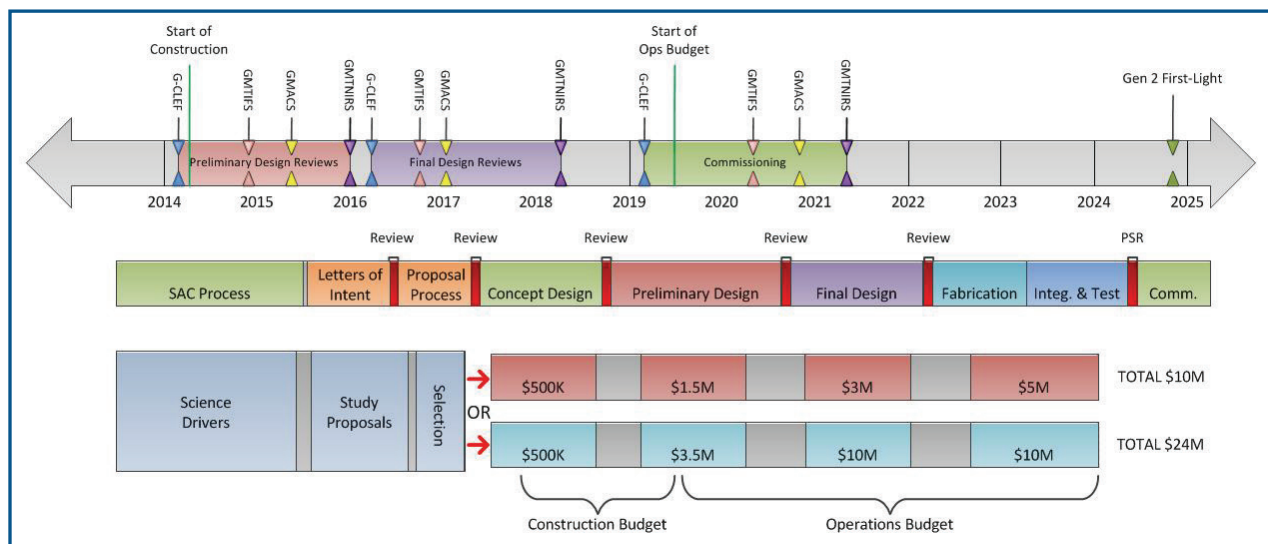

Figure 16. The current notion for beginning the procurement of a second generation instrument. Items along the top identify the milestones for first generation instruments. A selection process will occur in the 2017-2018 time frame, and may decide between a natural seeing and an AO-fed instrument. Cost numbers are notional.

5. DISCUSSION

The GMTO instrumentation program has progressed considerably since the last SPIE meeting. The instrument designs are far more mature and a plan for advancing to fabrication is in place. The facility requirements and designs have progressed in parallel with the instrumentation, and both have benefited from the bilateral development flow. This point has been especially evident for the AO systems where the delineation between the instruments and the facility is blurred. GMTO is now ready to advance the designs for a suite of instruments that promise to have a very high science impact. In addition, parallel activities have provided critical information in defining system requirements¹⁹ as well as software and controls concepts²⁰.

The roadmap development process is complete in broad terms; details remain to be worked out. The first generation suite includes instruments having broad science application. It takes advantage of GMT's wide field of view to provide excellent survey capabilities, includes instruments suitable for both bright- and dark-time, excellent and fair atmospheric conditions, as well as natural and AO modes.

Overall, we view the instrument development and selection processes as highly effective, and they will serve as the basis for bringing subsequent generation instrument suites to GMT.

ACKNOWLEDGEMENTS

J. Kern assisted with many of the figures. This material is based in part upon work supported through the National Science Foundation under Scientific Program No. 10 as issued for support of the Giant Segmented Mirror Telescope for the United States Astronomical Community, in accordance with Proposal No. AST-0443999 submitted by AURA.

REFERENCES

- [1] Jaffe, D. T., Depoy, D. L., Fabricant, D. G., Hinz, P. M., Jacoby, G., Johns, M., McCarthy, P., McGregor, P. J., Shectman, S. and Szentgyorgyi, A., "Science instrument development for the Giant Magellan Telescope," Proc. SPIE 7735, 72- (2010).
- [2] Johns, M., McCarthy, P., Raybould, K., Bouchez, A., Farahani, A., Filguiera, J., Jacoby, G., Shectman, S. and Sheehan, M., "Giant Magellan Telescope – Overview," Proc. SPIE 8444 (2012).
- [3] Bouchez, A., Acton, D. S., Bennet, F. H., Brusa-Zappellini, G., Codona, J. L., Conan, R., Connors, T., Durney, O., Espeland, B., Gauron, T. M., Hart, M., Hinz, P. M., Kanneganti, S., Kibblewhite, E. J., Knox, R. P., McLeod, B. A., McMahan, T., Montoya, M., Norton, T. J., Ordway, M. P., Parcell, S., Piatrou, P. K., Price, I., Roll, Jr., J. B., Trancho, G., Uhlendorf, K., et al , "The Giant Magellan Telescope adaptive optics program," Proc. SPIE 8447 (2012).
- [4] McCarthy, P. J. (ed.), "Giant Magellan Telescope Science Case", GMTO document GMT-SCI-DOC-00031 (2006).
- [5] GMTO Conceptual Design Review, "Scientific Instruments," Chapter 13, http://www.gmto.org/Resources/GMT-ID-01474-13.1_Introduction.pdf (2006).
- [6] Szentgyorgyi, A., Frebel, A., Furesz, G., Hertz, E. N., Norton, T. J., Bean, J., Bergner, H. W., Crane, J. D., Evans, J. D., Evans, I. N., Gauron, T. M., Jordan, A., Park, S. C., Uomoto, A., Barnes, S. I., Davis, W., Esienhower, M., Epps, H. W., Guzman, D., McCracken, K., Ordway, M. P., Plummer, D. A., Podgorski, W. A., Weaver, D. S., "The GMT-CfA, Carnegie, Catolica, Chicago Large Earth Finder (G-CLEF): a general purpose optical echelle spectrograph for the GMT with precision radial velocity capability," Proc. SPIE 8446 (2012).
- [7] DePoy, D. L., Marshall, J. L., Prochaska, T., Behm, T. W., Smee, S. A., Barkhouser, R. H., Hammond, R. P., Shectman, S. A., Papovich, C., "The GMACS spectrograph for the Giant Magellan Telescope," Proc. SPIE 8446 (2012).
- [8] Barkhouser, R. H., Shectman, S. A., DePoy, D. L., Marshall, J. L., Smee, S. A. Hammond. R. P., Prochaska, T., "Conceptual optical design for GMACS, a wide-field, multi-object, moderate resolution optical spectrograph for the Giant Magellan Telescope (GMT)," Proc. SPIE 8446 (2012).
- [9] Smee, S.A., Prochaska, T., Shectman, S. A., Hammond, R. P., Barkhouser, R. H., DePoy, D. L., Marshall, J. L., "Optomechanical design concept for GMACS: a wide-field multi-object moderate resolution optical spectrograph for the Giant Magellan Telescope (GMT)," Proc. SPIE 8446 (2012).
- [10] McGregor, P. J., Bloxham, G. J., Boz, R., Davies, J., Doolen, M. C., Ellis, M., Hart, J., Nielsen, J. J., Parcell, S., Sharp, R. G. and Stevanovic, D., "The GMT integral-field spectrograph (GMTIFS) conceptual design," Proc. SPIE 8446 (2012).
- [11] McGregor, P. J., Hart, J., Stevanovic, D., Bloxham, G., Jones, D., Van Harmelen, J., Griesbach, J., Dawson, M., Young, P. and Jarnyk, M. A., "Gemini South Adaptive Optics Imager (GSAOI)," Proc. SPIE 5492, 1033-1044 (2004).
- [12] McGregor, P. J., Hart, J., Conroy, P. G., Pfitzner, M. L., Bloxham, G. J., Jones, D. J., Downing, M. D., Dawson, M., Young, P., Jarnyk, M. and Van Harmelen, J., "Gemini near-infrared integral field spectrograph (NIFS)," Proc. SPIE 4841, 1581-1591 (2003).
- [13] Beets, T. A., Beno, J. H. and Worthington, M. S., "GMTNIRS mechanical design," Proc. SPIE 8446 (2012).

- [14] Yuk, I.-S., Jaffe, D. T., Barnes, S., Chun, M.-Y., Park, C., Lee, S., Lee, H., Wang, W., Park, K.-J., Pak, S., Strubhar, J., Deen, C., Oh, H., Seo, H., Pyo, T.-S., Park, W.-K., Lacy, J., Goertz, J., Rand and J. Gully-Santiago, M., "Preliminary design of IGRINS (Immersion GRating INfrared Spectrograph)," Proc. SPIE 7735, 54- (2010).
- [15] Fabricant, D. G., Fata, R. G., Brown, W. R., McLeod, B. A. and Mueller, M., "NIRMOS: a wide-field near-infrared spectrograph for the Giant Magellan Telescope," Proc. SPIE 8446 (2012).
- [16] Hinz, P. M., Codona, J. L., Guyon, O., Hoffman, W. F., Skemer, A., Hora, J. L., Tolls, V., Boss, A., Weinberger, A., Arbo, P., Connors, R., Durney, O., McMahan, T., Montoya, M. and Vaitheeswaran, V., "TIGER: a high contrast infrared imager for the Giant Magellan Telescope", Proc. SPIE 8446 (2012).
- [17] Sivanandam, S., Hinz, P. M., Heinze, A. N., Freed, M. and Breuninger, A. H., "Clio: a 3-5 micron AO planet-finding camera," Proc. SPIE 6269, 27- (2006).
- [18] Goodwin, M., Colless, M., Monnet, G. J., Saunders, W., Lawrence, J. S., Hopkins, A., Brzeski, J. K., Case, S., Miziarski, S., Muller, R., Smith, G. A., Tims, J. and Waller, L. G., "MANIFEST instrument concept and related technologies," Proc. SPIE 8446 (2012).
- [19] Maiten, J., Johns, M. W., Tranco, Saywer, D., G., Mady, P., "Systems engineering implementation in the preliminary design phase of the Giant Magellan Telescope," Proc. SPIE 8449 (2012).
- [20] Filgueira, J. M., Bec, M., Soto, J., Liu, N., "GMT software and controls overview," Proc. SPIE 8451 (2012).