

PROCEEDINGS OF SPIE

[SPIDigitalLibrary.org/conference-proceedings-of-spie](https://spiedigitallibrary.org/conference-proceedings-of-spie)

Systems engineering applied to ELT instrumentation: MANIFEST pre-conceptual design case

Hartmann, Vitor, Pires, Priscila, Faes, D. M., Ribeiro, Rafael, Oliveira, C. M., et al.

Vitor N. Hartmann, Priscila Pires, D. M. Faes, Rafael Ribeiro, C. M. Oliveira, Celestina Lacombe, Tayyaba Zafar, Jon Lawrence, Helen McGregor, Jessica Zheng, Michael Goodwin, "Systems engineering applied to ELT instrumentation: MANIFEST pre-conceptual design case," Proc. SPIE 11450, Modeling, Systems Engineering, and Project Management for Astronomy IX, 1145015 (13 December 2020); doi: 10.1117/12.2576148

SPIE.

Event: SPIE Astronomical Telescopes + Instrumentation, 2020, Online Only

Systems engineering applied to ELT instrumentation: MANIFEST pre-conceptual design case

Vitor N. Hartmann^a, Priscila Pires^a, D. M. Faes^a, Rafael Ribeiro^a, C. M. Oliveira^a, Celestina Lacombe^b, Tayyaba Zafar^b, Jon Lawrence^b, Helen McGregor^b, Jessica Zheng^b, and Michael Goodwin^b

^aInstitute of Astronomy, Geophysics and Atmospheric Sciences, Rua do Matão 1226, Cidade Universitária, São Paulo, SP, Brasil 05508-090

^bAustralian Astronomical Optics – Macquarie University, 105 Delhi Rd, North Ryde NSW 2113, Australia

ABSTRACT

Large or complex systems tend to be challenging when it comes to managing their project and construction while keeping the costs at an acceptable level. Systems Engineering aims not only to reduce that difficulty by systematically flowing down the top-level user needs to the bottom level parts specification, but also by describing the full aspects of its lifecycle. Moreover, together with Systems Management, they aid the completion of intricate projects, such as professional telescopes. This paper shows how Systems Engineering and Systems Management are helping the construction of one important instrument for the Giant Magellan Telescope: MANIFEST, which is a robotic fiber-optic positioning system that improves the capabilities of other instruments in the telescope. It can increase and even split their field of view into two or more instruments. Its Operations Concept is briefly explained, and the flowdown from the Observatory Architecture and the Science Cases, with their corresponding Science Requirements, is presented. Interfaces with other equally important instruments are described, such as GMACS, a wide-field multi-object moderate-resolution optical spectrograph, and G-CLEF, a high-stability, high-resolution, echelle spectrograph operating in the visible range of the spectrum. Managerial aspects of the processes and documents involved are also explained, as well as the next steps for the incoming Conceptual Design phase.

Keywords: Giant Magellan Telescope, Extremely Large Telescopes, Many Instruments Fiber System, Systems Engineering, MANIFEST, GMT, ELT, SE.

1. INTRODUCTION

When developing large or complex systems, one main difficulty is to plan it to meet the stakeholder needs while still being producible and maintainable. More than that, the system must exist cost-effectively over the designed life span while still maintaining acceptable risks.¹ Systems Engineering (SE) is the area of engineering that intends to describe not only the systems design, development, fabrication, construction, integration, verification, commissioning, and operation, but also the organization, processes, tools, and methodology that are to be implemented to ensure a coordinated effort of the teams involved.

The Giant Magellan Telescope (GMT) is a 25m-class ground-based visible-infrared telescope for basic research in astrophysics, exoplanet science, and cosmology.² This telescope is being developed by the GMT Organization (GMTO), a corporation that will also execute the operation of the GMT facility. GMTO is a consortium of academic and research institutions, of which the Fundação de Amparo à Pesquisa do Estado de São Paulo (FAPESP - The São Paulo Research Foundation) is one of the twelve founder institutions. The GMT Brazilian Office (GMTBrO) is responsible for the activities developed in that country.

Because of GMT's large number of instruments, and a limited line of sight, splitting the light into several instruments could allow more science to be performed simultaneously. Moreover, despite having a field of view

Further author information: (Send correspondence to V.N.H.)
V.N.H.: E-mail: vitor.hartmann@usp.br

Modeling, Systems Engineering, and Project Management for Astronomy IX, edited by George Z. Angeli,
Philippe Dierickx, Proc. of SPIE Vol. 11450, 1145015 · © 2020 SPIE
CCC code: 0277-786X/20/\$21 · doi: 10.1117/12.2576148

(FoV) of 20 arcmin, science instruments cannot use it completely. Therefore, collecting the light only of selected objects and transporting it directly to the desired instrument would also improve the individual usable FoV of the instruments.

MANIFEST is the GMT MANY Instrument FibEr SysTem, a robotic fiber-optic positioning system, currently being developed by AAO, Australian Astronomical Optics, which will allow the use of the full GMT's 20 arcmin circular FoV, by some instruments. MANIFEST will consist of hundreds of Starbug robots that patrol the GMT field-of-view and feed currently planned optical spectrographs (high resolution G-CLEF and medium resolution GMACS) and future spectrographs (including infrared spectrographs). MANIFEST will have multiple fiber configurations, ranging from single fibers to multiple integral field units to single integral field units (IFUs).

The MANIFEST instrument aims to enhance the functionality of the GMT spectrographs by offering capabilities such as increased FoV, increased multiplex capability, multiple deployable IFUs, increased spectral resolution and/or wavelength coverage via image-slicing, the opportunity for simultaneous observation with multiple instruments, the possibility of a gravity-invariant spectrograph mounting, the potential for OH sky background suppression via fiber systems in the near-infrared, and the versatility of adding new instruments in the future. The goal is to make MANIFEST a GMT facility in a way that any natural seeing or GLAO instrument can make use of it. This way MANIFEST will expedite many galactic and extragalactic surveys and will greatly increase GMT's scientific productivity.

MANIFEST presents several design challenges, such as the suitability regarding the components size, instrument operation stability and metrology.³ The increasing costs with the instrument's size and its increased technical complexity are a few of the reasons to seek the support of SE practices.

Moreover, because MANIFEST is a collaborative effort between different countries, international universities, and research institutions, SE plays an important role in the achievement of its functions and desired performance, in the interfaces to the GMT and in the integration of the different technical teams.

In Section 2, the methodology used to perform SE is explained; Section 3 briefly introduces how management was done. Section 4 and Section 5 describe the science to be performed and the instrument, respectively. In both of them, requirements flowdown, and traceability are detailed. MANIFEST interfaces are presented in Section 6, and final remarks are in Section 7. Acknowledgments and References are placed at the end of this article.

2. METHODOLOGY

MANIFEST pre-Conceptual Design (pre-CoD) guidelines come mainly from the pre-CoD Statement of Work (SoW), which explains what shall be done in this phase. The SoW forms a pre-CoD interfacing and design study, into which the instrument subsystems designs are progressed to develop the interfaces to the telescope and to the other instruments.⁴

The SE Management Plan (SEMP) is the main reference to manage the SE effort necessary to comply with the SoW. This plan covers the organizational responsibilities over it; the processes involved in designing the instrument; the products to be developed to direct and manage the GMT technical effort; and the methodologies for communication within the systems engineering group and the rest of the project team; and the descriptions of SE involvement, and planning for external and internal review processes.²

Besides those two main references for MANIFEST pre-CoD, several other documents describe under what conditions the SoW shall be developed. The GMT Review and Products Guidance, for instance, provides high level to low-level information that allows a user to view the success criteria as a project matures for a specific review or the detailed definition of a deliverable.⁵

These documents were used to develop, document, and communicate the SE documents planned for this pre-CoD. Seven of them are highlighted here, supported by several other studies: the Science Cases Document (SCD), the Science Requirements Document (SRD), the Operations Concept Document (OCD), the Instrument Requirements Document (IRD), and three Interface Control Documents (ICD). They are related to each other, and modifications can require updates into one or more of the others. In Figure 1, the relation between these documents is represented.

MANIFEST has just completed the pre-CoD phase, and the following sections describe what SE has achieved so far and how it was managed.

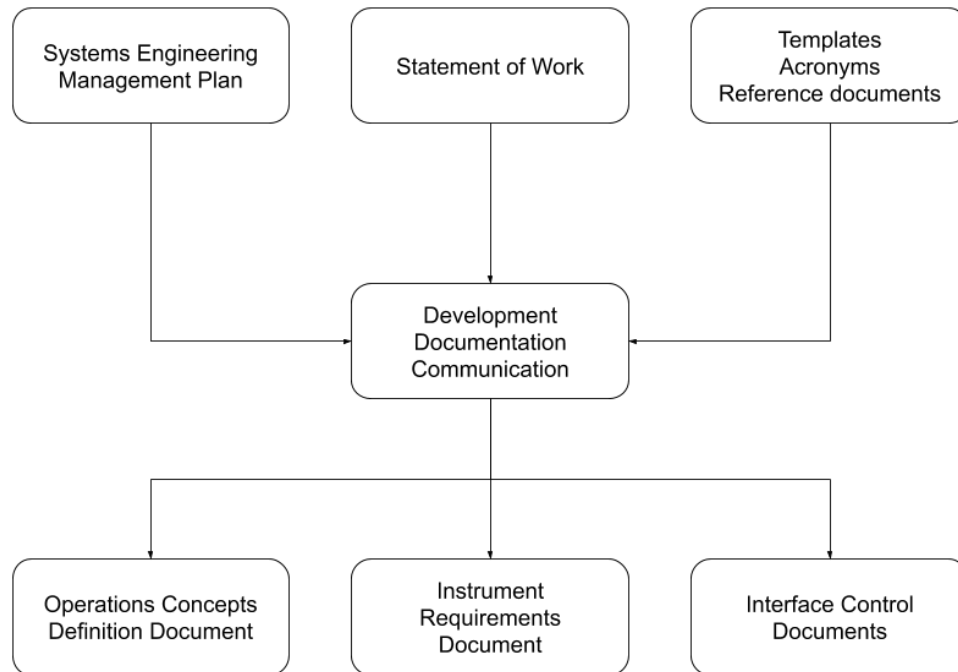

Figure 1. MANIFEST pre-CoD SE documents (authors).

3. MANAGEMENT

Project Management and Project Systems Engineering run side by side until the end of the instrument’s lifecycle. Despite dealing directly with resources and team organization, management tasks aim to track, control, and report work, cost, and schedule progress. MANIFEST pre-CoD study started in Jan 2018, with tracking achieved upon the completion of design milestones. Risks will always be a part of the project, whose identification is part of the risk database developed. The reporting and documentation deliverables set receives inputs from the several areas and partners of the project, including the System Definition Files (SDFs). All the organizations involved were responsive, keen to engage, and collaborate as much as their design advancements, workflow and workload allowed. A summary of the processes involved, and some of the deliverables, both for this pre-CoD, is represented in Figure 2.

4. SCIENCE

Science requirements come from two sources: directly from the SCD and indirectly from the Observatory Architecture Document (OAD). The SCD presents a broad series of science objectives that can be accomplished by MANIFEST. From the SCD, the higher-level science requirements can be derived. The OAD captures the top-level system design, consistent with the Observatory Requirements. It defines the subsystems and their interactions, and it also enumerates the performance and the resource allocations among the subsystems. The requirements in OAD are traceable to the GMT Science Cases using the Observatory Requirements Document (ORD) and the GMT SRD. Requirements from the OAD will be discussed in Section 5.

4.1 Science Cases

MANIFEST will enhance the functionality of the GMT spectrographs by offering capabilities such as: increasing the field of view, deployable IFUs, providing multiplex capability, simultaneous observations with multiple instruments etc. MANIFEST will advance the fields of galactic archaeology, stellar astrophysics, galaxy kinematics, together with the developments in galaxy formation and evolution. MANIFEST with multiplexing and IFUs can grow the surveys exponentially and obtain more positional, kinematical, and chemical information by

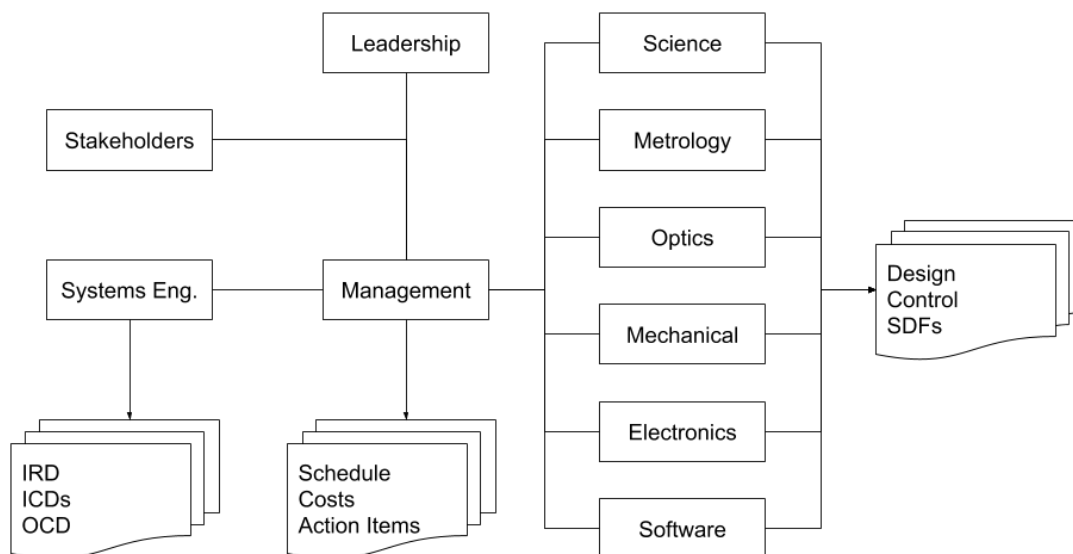

Figure 2. Summary of processes and deliverables of MANIFEST project management (authors).

observing millions and billions of stars and galaxies in the universe. The science cases for this instrument include five different astronomy fields, in a total of fifteen science cases. Figure 3 shows a simplified relationship between each other. The topics listed for the science cases are not a complete list of possible benefits to the science community but are representative of the science requirements.

4.2 Science Requirements

The fifteen science cases listed in the SCD interfaces mainly with four instruments, having eight modes in total. These are interfaces with G-CLEF (three modes), GMACS (three modes), near-infrared instruments, and polarimeters. The science cases generate more than seventy science requirements inside the SRD. These requirements are labeled level 1 requirements. Figure 3 shows three different level 1 requirements that generate a single level 4 requirement (numbering of levels according to SEMP). This is a case of requirements with multiple parents that often appear when flowing down from the SRD to the IRD.

5. INSTRUMENT

At this point, two main documents are related to the instrument: the OCD and the IRD. Each is discussed in more detail in the next subsections.

5.1 Operations Concept

The OCD explains how the instrument will be operated to fulfill its required scientific function. In this case, the OCD provides the overall picture of MANIFEST during the operations phase, describing the desired system features and characteristics from an operational perspective, facilitating an understanding of technical and programmatic issues related to the use of the instrument, guiding the design and implementation of operational procedures and staffing plans, and providing, during and after system requirements analysis, the context within which requirements and goals should be interpreted.

MANIFEST needs to prioritize daytime for maintenance and preparations, and the nighttime for science observations. It will not do science without an instrument attached, and it will not support wavelengths outside the ADC range. Plus, since the Observatory Facilities provide utilities to the instruments, such as power, coolant, compressed air, cryogenic cooling, hydraulics, and vacuum, all the interfaces to the instruments need to be defined in cooperation with the GMTO team, such as GMACS and G-CLEF.

MANIFEST has three operation modes: standard, multiple, and calibration. In standard mode, MANIFEST will feed a single GMT instrument with fibers. When in multiple mode, it will feed two or more GMT instruments simultaneously, and when in calibration mode, MANIFEST fibers will position and move for its calibration. Figure 4 illustrates these operation modes.

MANIFEST has three Instrument States: the Environmentally Controlled State is the state in which the system is on standby to be protected from dangerous conditions. From that state, it can transition to Science operations. Science Operations State is a state in which the system will conduct science observations or nighttime engineering procedures, including the Daily operations illustrated in Figure 5. And the Daytime Maintenance State is a state in which the system will be performing maintenance, daytime procedures, and daytime science calibrations (if needed).

5.2 Instrument Requirements Document

The flowdown from the OAD is similar to the flowdown of requirements of the SCD. In Figure 3, one example of the flowdown from the SCD, through the SRD, and up to the level 5 of the IRD, was given. Now, Figure 6 shows the flowdown of requirements from the OAD, with four examples to level 4 of the IRD. There are three main types of requirements: functional, performance, and interface.

Functional requirements are related to the functions that a system or its components shall be capable of executing. Performance requirements specify criteria that can be used to judge the operation of a system. Furthermore, interface requirements are those that describe all the interfaces between systems and subsystems. So far, more than 200 requirements were identified, and the proportion between these three types of requirements in MANIFEST is as shown in Figure 7.

6. INTERFACES

MANIFEST interfaces with several subsystems of GMT. However, at this point in project development, five of them were further described in this section. Also, to facilitate this initial analysis of the interfaces, three of the GMT subsystems were merged in a single ICD. This document will be split again once each interface develops. Figure 8 depicts MANIFEST interfaces and the five considered in this analysis.

6.1 GMACS

GMACS is the GMT Multi-object Astronomical and Cosmological Spectrograph project, a wide-field multi-object moderate-resolution optical spectrograph to be installed on the GMT.⁶ GMACS will be one of the first members of the GMT's first-generation instruments, which must be operational when GMT starts operating.⁷ Due to the broad range of science cases, GMACS will probably be the most widely used instrument in the early years of GMT operation.⁸

At the current design stage, GMACS has a 7.4 arcmin circular FoV, a small capability compared to the GMT 20 arcmin FoV. MANIFEST will allow GMACS to increase its FoV to the GMT's full performance. Optical fibers will achieve the integration, and two possibilities are envisaged for that: a temporary link between the two instruments; or a permanent link between them. Both are shown in Figure 9.

The preferred fiber route between MANIFEST and GMACS is a temporary link between the two instruments. The advantage of this connection is the higher throughput due to a smaller fiber length. A fiber mask deployment mechanism (FMDM) inside the MANIFEST instrument bay inserts the fibers into the GMACS instrument bay. In this case, the fiber route is entirely contained within the MANIFEST Instrument Mounting Frame (IMF). A second possible fiber route between MANIFEST and GMACS is a permanent connection within the telescope structure, although still allowing instrument movement between the deployed and stowed positions. The advantage of this solution is that the permanent connection increases reliability by reducing link failure risks.

Both solutions are still under analysis for selection, and they strongly depend on the design of the Gregorian Instrument Rotator (GIR) structure. Recently, some changes to the IMF were proposed, which would interfere with the MANIFEST design. The main issue in that modification is the reduction of available room inside

the MANIFEST IMF. On the other hand, the initially predicted intrusion of GMACS camera detector into MANIFEST IMF would no longer exist.

GMACS concept has articulated cameras that allow different working modes. However, the GMACS CoD required that the blue camera is projected outside GMACS IMF. The MANIFEST current concept only uses half of Direct Gregorian (DG) volume, so MANIFEST team had agreed to allow GMACS intrusion to its IMF. In order to do so, the MANIFEST IMF structure was modified to allow rotational movement from the GMACS blue camera detector. The detector will be allocated between two of the three sets of fibers for the Starbugs. Figure 10 draws that arrangement.

MANIFEST and GMACS must be in opposite DG positions, or MANIFEST would have to allow this intrusion in two of its faces due to the GIR design. That is because, assuming MANIFEST is on-axis and GMACS is in its stowed position, it is only possible for GMACS to extrapolate its volume through its surface turned to the center of the GIR. When GMACS is on-axis and MANIFEST is stowed, MANIFEST's corresponding surface will only be the same if both instruments are located in opposite DG bays. If MANIFEST were to be stowed in a perpendicular bay, another surface would also need to receive the intrusion.

Nevertheless, the physical connection is not the only interface existing with GMACS. Since GMACS optics is designed to work in the DG Narrow-Field (DGNF) and MANIFEST will work using the full focal plane in the DG wide-field (DGWF), a solution must be developed to reposition the focal plane. Thus, specific optics were added at the MANIFEST fiber output, under MANIFEST responsibility. This solution is under development and, similar to other open items such as software, control, project schedule, and flexure compensation, will be further described in the subsequent phase.

6.2 G-CLEF

G-CLEF, the GMT-Consortium Large Earth Finder, is a high-stability, high-resolution, echelle spectrograph operating in the visible range of the spectrum. Because of its resolution and expected stability, it will be mounted inside a thermal-stabilized and vibration-isolated room on the gravity invariant platform (Gravity Invariant Station, GIS) at the GMT.¹⁰ G-CLEF is the only high-resolution spectrograph planned to be operational during the first decade after the three Extremely Large Telescopes (ELTs), currently under construction, enter operation.

G-CLEF will, like GMACS, use MANIFEST to increase its FoV. Also, since G-CLEF optics is designed to work in the DGNF and MANIFEST will work using the full focal plane in the DGWF, specific optics were added at the MANIFEST fiber output, under MANIFEST responsibility. However, there are some particularities of G-CLEF that makes this interface somewhat different from GMACS. One of them is that G-CLEF is distributed in several locations of the Mount: the spectrograph itself is located at the GIS, but its fiber selector is at the Instrument Platform (IP). On the other hand, MANIFEST is located at the DG. Thus, additional fiber selector and filters are necessary inside the MANIFEST volume. This device is called the filter box mechanism, which, just like software and control, will be further described in the next phase. Figure 11 shows the GIS and IP, among other locations.

6.3 GMT

In this section, all interfaces between MANIFEST and the GMT were included. It is not a definitive reference, and, as mentioned at the beginning of this section, they will be split into several interface documents. For the time being, three main interfaces are described: with the Observatory Control System (OCS), with the Mount, and with the wide-field Corrector-ADC System.

Misalignments between the telescope DGNF optical surface (decentering, rotation, focus, and tip-tilt) and MANIFEST input focal plane need to be corrected to MANIFEST to work properly. It is assumed that some misalignments will be corrected by the GMT's Acquisition, Guiding and Wavefront-sensing (AGWS) system, taking care of acquisition and guiding. However, there is a non-common path between the AGWS system and the MANIFEST Glass Field Plate (GFP) with some flexure components. Thus, a system is required to measure the misalignment at the focal plane and to communicate with GMT about possible actions. The OCS interface manages this communication.

Lenses, provided by the GMT, are necessary to compensate for atmospheric dispersion and to correct wide-field observations. However, that should happen after the commissioning of MANIFEST, and some actions shall be taken to allow either observation on a reduced 12 arcmin FoV or the full 20 arcmin FoV. This choice depends mainly on cost since the design of the GFP and corresponding optics are different for each case.

At last, the Mount interface is marked by mechanical interferences between the instrument and Mount structure. One of them is the fiber links to instruments. GMACS link was already described in Section 6.1, but the interface with the Mount will only happen if the permanent link is selected, as shown in Figure 9. A similar situation occurs regarding the G-CLEF link, though in this case, the length of the fibers is up to 40 meters. Figure 12 shows a proposed solution, which requires further analysis to allow proper selection and description.

7. FINAL REMARKS

This article summarizes the SE efforts employed in the project during the pre-CoD, mainly focused on project management, requirements management and flowdown, and interfaces control. MANIFEST was submitted to the pre-Conceptual Design Review (pre-CoDR) in late April this year, whose result was returned as approved in the middle of 2020.

GMT's SEMP foresees three main design phases for its instruments: Conceptual Design (CoD), Preliminary Design (PD) and Critical Design (CD), before the manufacturing and assembly phases. Incoming CoD phase was approved and should start in November this year (2020).

SE practices are critical for the MANIFEST project, as the telescope's design, although advanced, still accommodates changes with a strong impact on the interfaces with it. The SE tools described here are essential to ensure that the instrument returns as much science as possible, within the expected costs and terms.

MANIFEST SE work is expected to increase in intensity in the next phases of design since the development and analysis of the system are only the beginning, and further system definition will be necessary until the end of the instrument lifecycle.

ACKNOWLEDGMENTS

Vitor thanks Mario de Almeida for the useful discussions; Daniel Bednarsky, for the information about DOORs in GMTO; and Aline Souza, former member of GMTBrO that helped this pre-CoD results.

REFERENCES

- [1] Faes, D. M., Souza, A., Froning, C., Schmidt, L., Bortoletto, D., Cook, E., DePoy, D. L., Ji, T.-G., Jones, D., Lee, H.-I., Marshall, J. L., Oliveira, C. M., Pak, S., Papovich, C., Prochaska, T., Ribeiro, R. A., and Taylor, K., "Systems engineering applied to elt instrumentation: the gmacs case," in [*Modeling, Systems Engineering, and Project Management for Astronomy VIII*], *Proc. SPIE 10705* **107051A**, <https://doi.org/10.1117/12.2311352> (10 July 2018).
- [2] Souza, J., "GMT Systems Engineering Management Plan: GMT Document." GMT-DOC-00002_Rev.G. GMTO Internal report. Unpublished. (2018).
- [3] Russell, A. P., Monnet, G., Quirrenbach, A., Bacon, R., Redfern, M., Andersen, T., Ardeberg, A., Atad-Ettdedgui, E., , and Hawarden, T. G., "Instruments for a european extremely large telescope: the challenges of designing instruments for 30- to 100-m telescopes," in [*Ground-based Instrumentation for Astronomy*], *Proc. SPIE 5492*, <https://doi.org/10.1117/12.551473> (30 September 2004).
- [4] Contos, A., "Statement of Work for MANIFEST pre-Conceptual Design Study: GMT Statement of Work." GMT-SOW-03063_Rev.A. GMTO Internal report. Unpublished. (2017).
- [5] Souza, J., "GMT Review and Products Guidance: GMT Document." GMT-REF-03359_Rev.B. GMTO Internal report. Unpublished. (2019).
- [6] DePoy, D. L., Schmidt, L. M., Ribeiro, R., Taylor, K., Jones, D., Prochaska, T., Marshall, J. L., Cook, E., Froning, C., Ji, T.-G., Lee, H.-I., Faes, D. M., Souza, A., Bortoletto, D., de Oliveira, C. M., Pak, S., and Papovich, C., "Gmacs: a wide-field, moderate-resolution spectrograph for the giant magellan telescope," in [*Ground-based and Airborne Instrumentation for Astronomy VII*], *Proc. SPIE 10702* **107021X**, <https://doi.org/10.1117/12.2313940> (6 July 2018).

- [7] Prochaska, T., Sauseda, M., Beck, J., Schmidt, L., Cook, E., DePoy, D. L., Marshall, J. L., Ribeiro, R., Taylor, K., Jones, D., Froning, C., Pak, S., de Oliveira, C. M., Papovich, C., Ji, T.-G., and Lee, H.-I., “Optomechanical design concept for the giant magellan telescope multi-object astronomical and cosmological spectrograph (gmacs),” in [*Ground-based and Airborne Instrumentation for Astronomy VI*], *Proc. SPIE 9908* **9908A3**, <https://doi.org/10.1117/12.2233530> (9 August 2016).
- [8] Ribeiro, R. A., Jones, D., Schmidt, L. M., Taylor, K., Cook, E., DePoy, D. L., Faes, D., Froning, C., Ji, T.-G., Lee, H.-I., Marshall, J. L., de Oliveira, C. M., Pak, S., Papovich, C., Prochaska, T., and Souza, A., “Optical design for the giant magellan telescope multi-object astronomical and cosmological spectrograph (gmacs): design methodology, issues, and trade-offs,” in [*Optical Design and Engineering VII*], *Proc. SPIE 10690* **106902S**, <https://doi.org/10.1117/12.2313528> (5 June 2018).
- [9] Pires, P., Hartmann, V. N., Lawrence, J., and McGregor, H., “MANIFEST to GMACS Interface Control Document.” GMACS-ICD-01037_A2. GMTO Internal report. Unpublished. (2020).
- [10] Fűrész, G., Epps, H., Barnes, S., Podgorski, W., Szentgyorgyi, A., Mueller, M., Baldwin, D., Bean, J., Bergner, H., Chun, M.-Y., Crane, J., Evans, J., Evans, I., Foster, J., Gauron, T., Guzman, D., Hertz, E., Jordán, A., Kim, K.-M., McCracken, K., Norton, T., Ordway, M., Park, C., Park, S., Plummer, D., Uomoto, A., and Yuk, I.-S., “The g-clef spectrograph optical design,” in [*Ground-based and Airborne Instrumentation for Astronomy V*], *Proc. SPIE 9147* **91479G**, <https://doi.org/10.1117/12.2057153> (28 July 2014).
- [11] “GMT System Level Preliminary Design Review: Telescope.” GMT SLPDR Section 6. GMTO Internal report. Unpublished. (2013).
- [12] Hartmann, V. N., Lawrence, J., Waller, L., McGregor, H., Lacombe, C., Goodwin, M., and Zheng, J., “MANIFEST to GMT Interface Control Document.” MANIFEST-ICD-00001.6. GMTO Internal report. Unpublished. (2020).

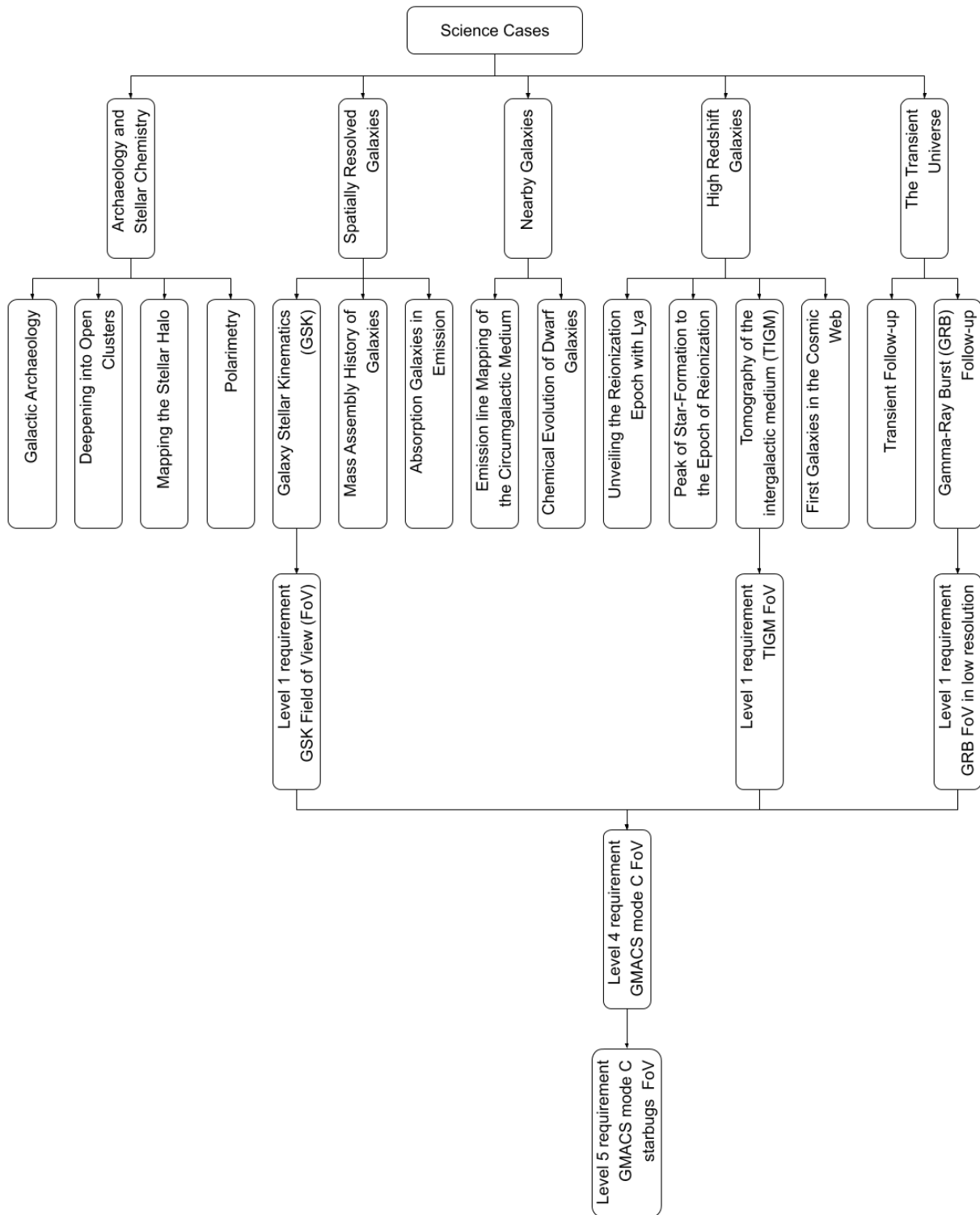

Figure 3. SCD requirements flowdown, with one example through the SRD and up to the level 5 of the IRD (authors).

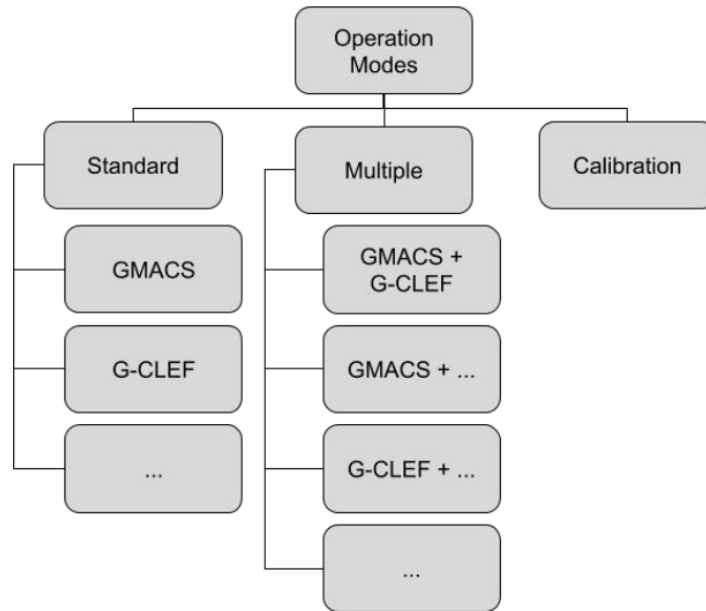

Figure 4. MANIFEST operation modes (authors).



Figure 5. MANIFEST simplified daily operations A typical day (and night) involves multiple positions, unique for each observation (authors).

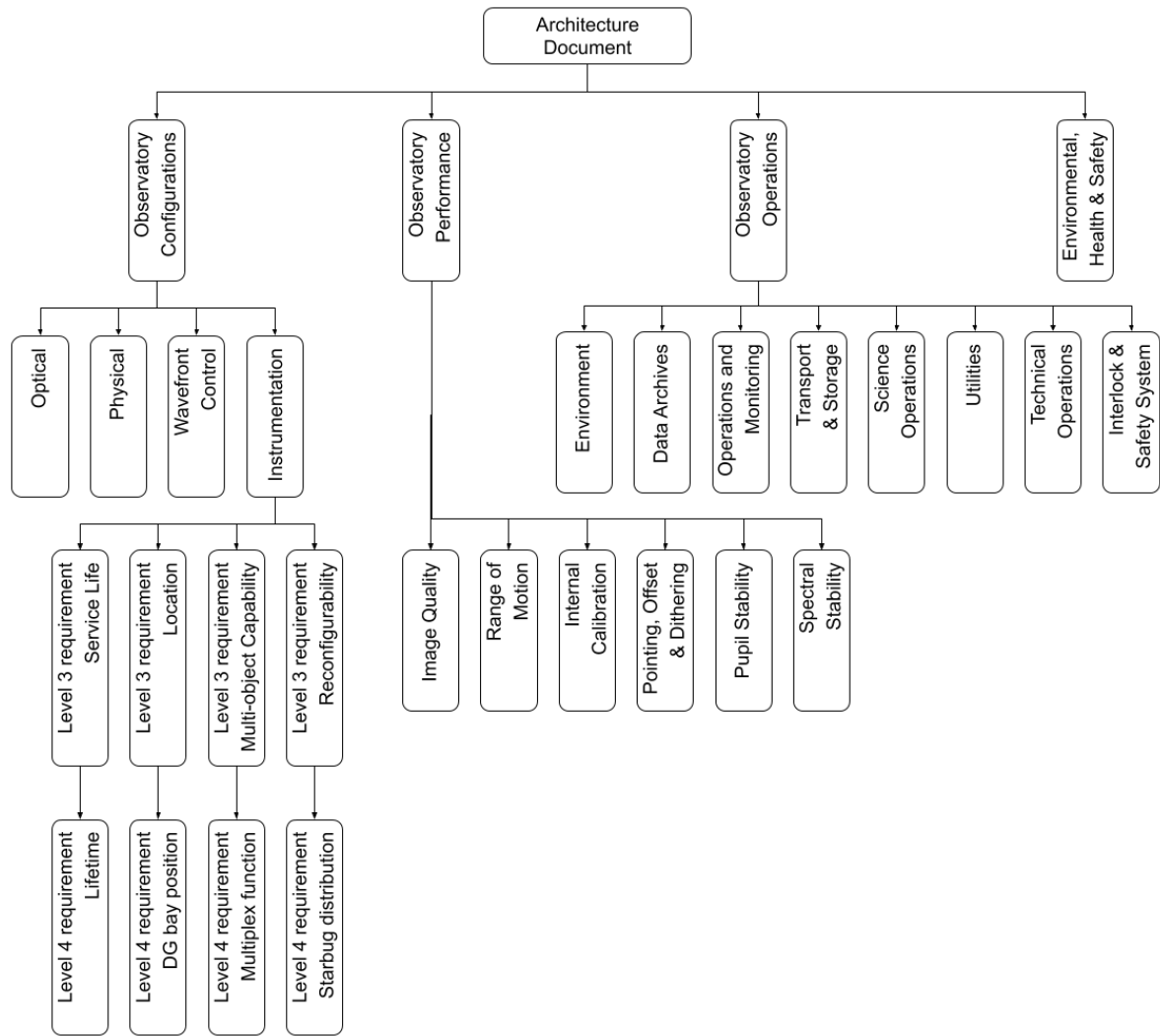

Figure 6. Flowdown of requirements from the OAD, with four examples to the level 4 of the IRD (authors).

Requirements by type

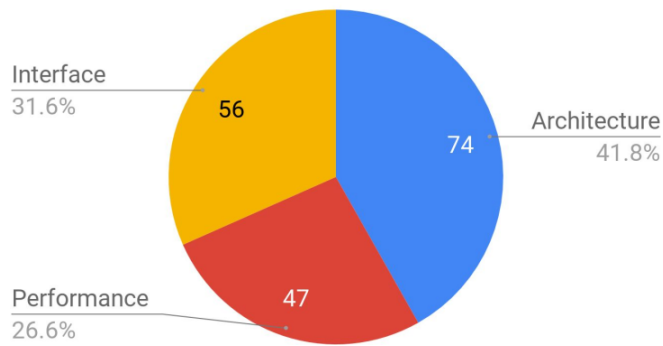

Figure 7. Types of requirements and their participation for MANIFEST in pre-CoD phase (authors).

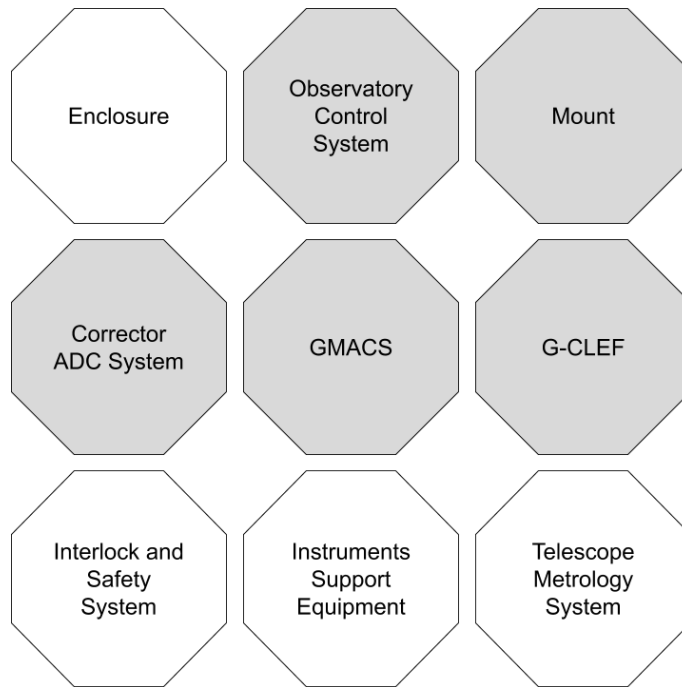

Figure 8. Subsystems that MANIFEST interfaces with. Those in gray were considered in this analysis (authors).

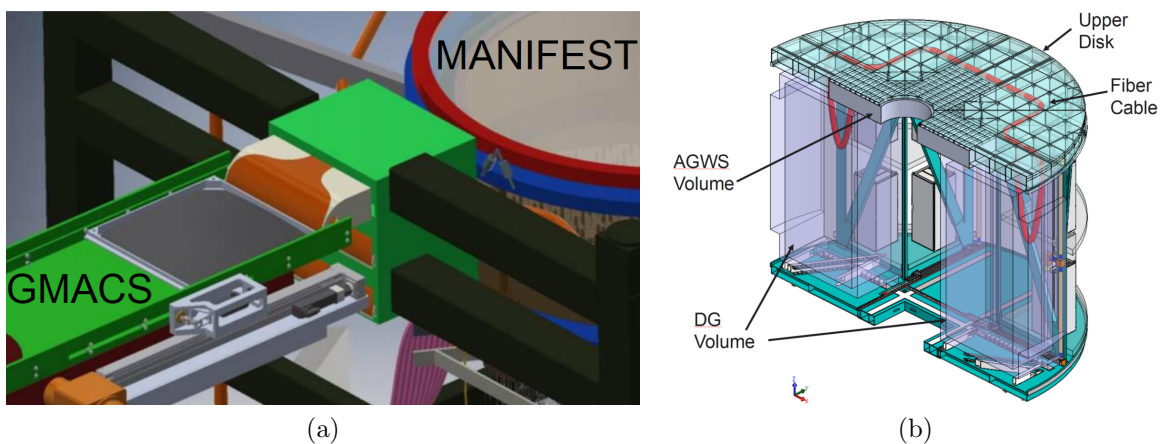

Figure 9. Possible solutions for MANIFEST-GMACS link: (a) temporary; (b) permanent (Adapted from 9).

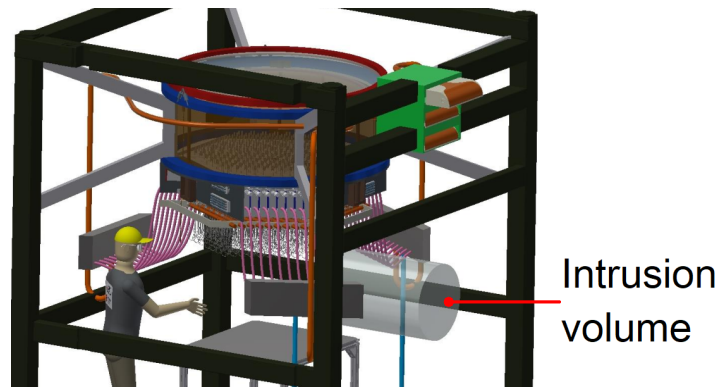

Figure 10. GMACS intrusion volume inside MANIFEST (Adapted from 9).

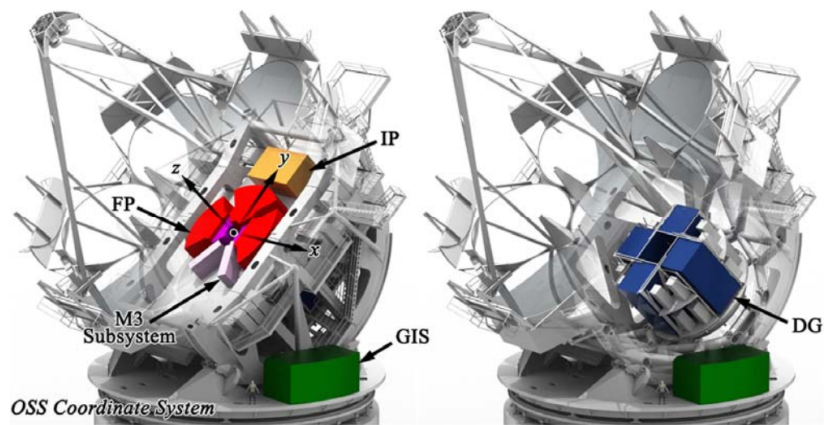

Figure 11. Locations of instruments in GMT (Adapted from 11).

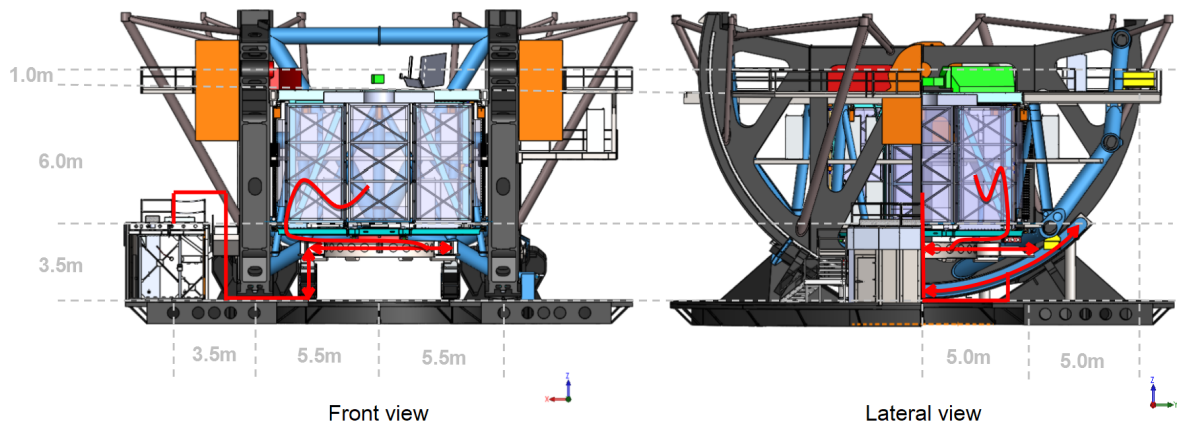

Figure 12. G-CLEF link and interface with the Mount (Adapted from 12).